

HUB30 4K BYOM Matrix Switcher

Quick Start Guide

Package Contents

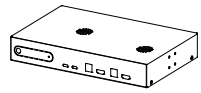

HUB30

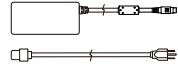

Power Adapter & Power Cord

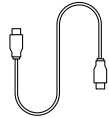

USB-C to C 3.2 Gen 2 Cable (2 m / 6 ft)



USB-A to B 3.0 Cable (1.5 m / 4.92 ft)

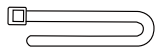

Cable Tie (x17)

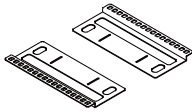

Cable Fixing Plate (x2)

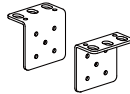

Rack Mount Bracket (x2)



Terminal Block 3-pole (x1)



M3 x 5.0 mm Truss Head Screw (x8)



M3 x 10 mm Screw (x4)



Quick Start Guide

User Manual and Software:
www.aver.com/download/HUB30



Warranty Policy:
communication.aver.com/warranty



Parts Info

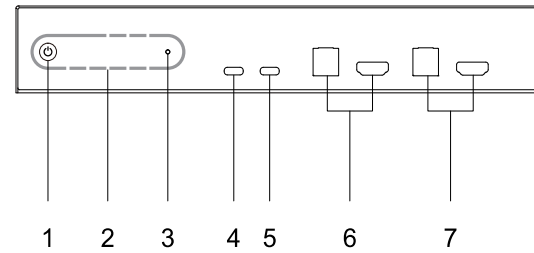

Front View

1. Power Button
 - The device automatically powers on when connected to power
 - Press and hold for 5 seconds to enter Standby Mode. Press once to wake up.
2. LED Indicators
3. Reset Hole
 - Insert a paper clip, push in and hold for 5 seconds to reset to default settings.
4. Input 1: USB-C 3.0 Port with Charging
5. Input 2: USB-C 3.0 Port
6. Input 3: USB-B 3.0 / HDMI Ports
7. Input 4: USB-B 3.0 / HDMI Ports

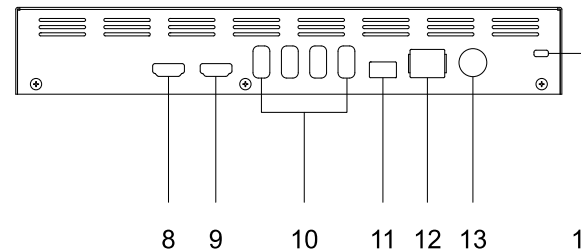

Rear View

8. HDMI Output Port 1
9. HDMI Output Port 2
10. USB-A 3.0 Ports
11. RS-232 Port
12. Ethernet Port
13. DC Power Jack
14. Kensington Lock

LED Indicators

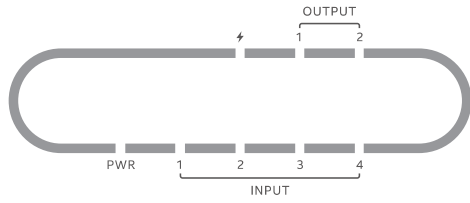

LED	Color	Status
Power	Solid green	Operational
	Solid orange	Standby
	Flashing green	Firmware update
	Flashing orange	Factory reset
USB-C charging ⚡	Solid green	Charging
Input 1-4	Solid green	Connected
Output 1-2	Solid green	Connected

Dimensions

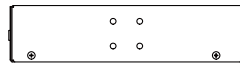
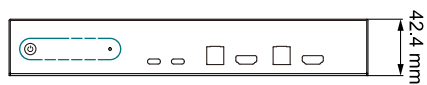
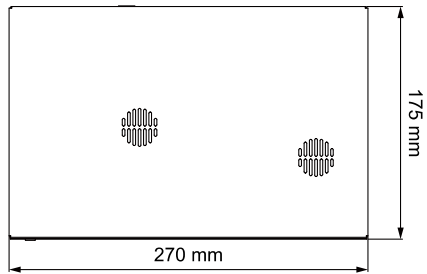

Cable Fixing Plate Installation

1. Secure the cable fixing plate to the device with the included M3 x 5.0 mm screws (x4).
2. Connect the cables.
3. Use the cable ties to secure the cables and cable fixing plate.

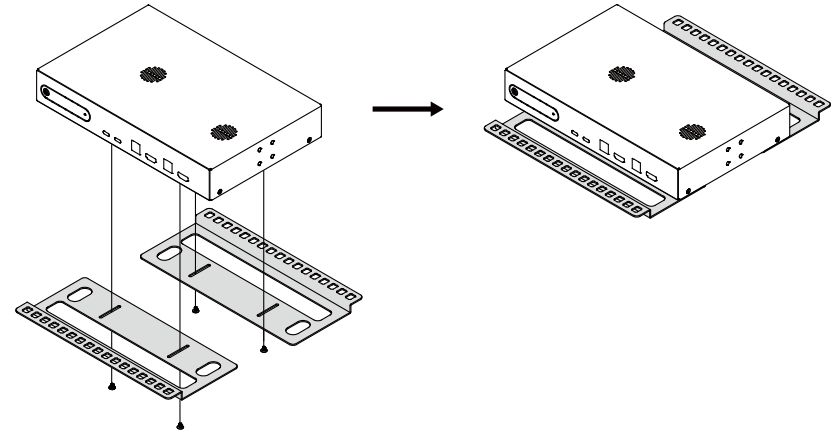

Desk Mount Installation

1. Secure the rack mount brackets on the device with the included M3 x 5.0 mm screws (x4).
2. Install the rack mount brackets and device under the desk with the included M3 x 10 mm screws (x4).
Make sure the fan vents aren't blocked.

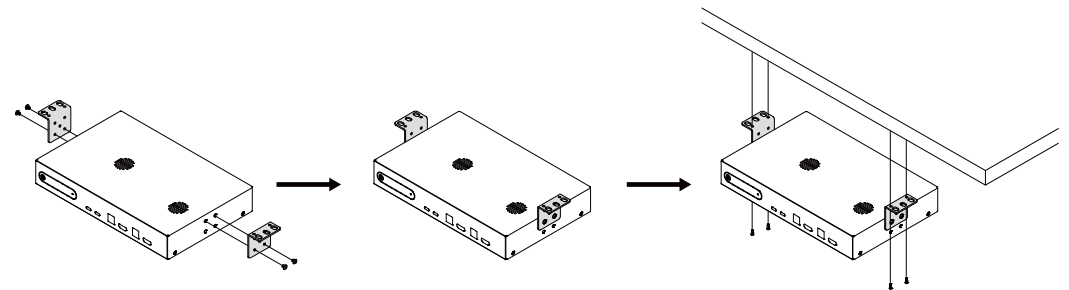

Connections

To share your computer screen, connect your computer to an input port using a USB-C, USB-B or HDMI cable, then connect an HDMI display to an HDMI output port using an HDMI cable.

Note: To connect via USB-C, make sure your computer supports DisplayPort Alternate (DP Alt) Mode. Look for the DisplayPort logo  or check your device specifications to confirm compatibility.

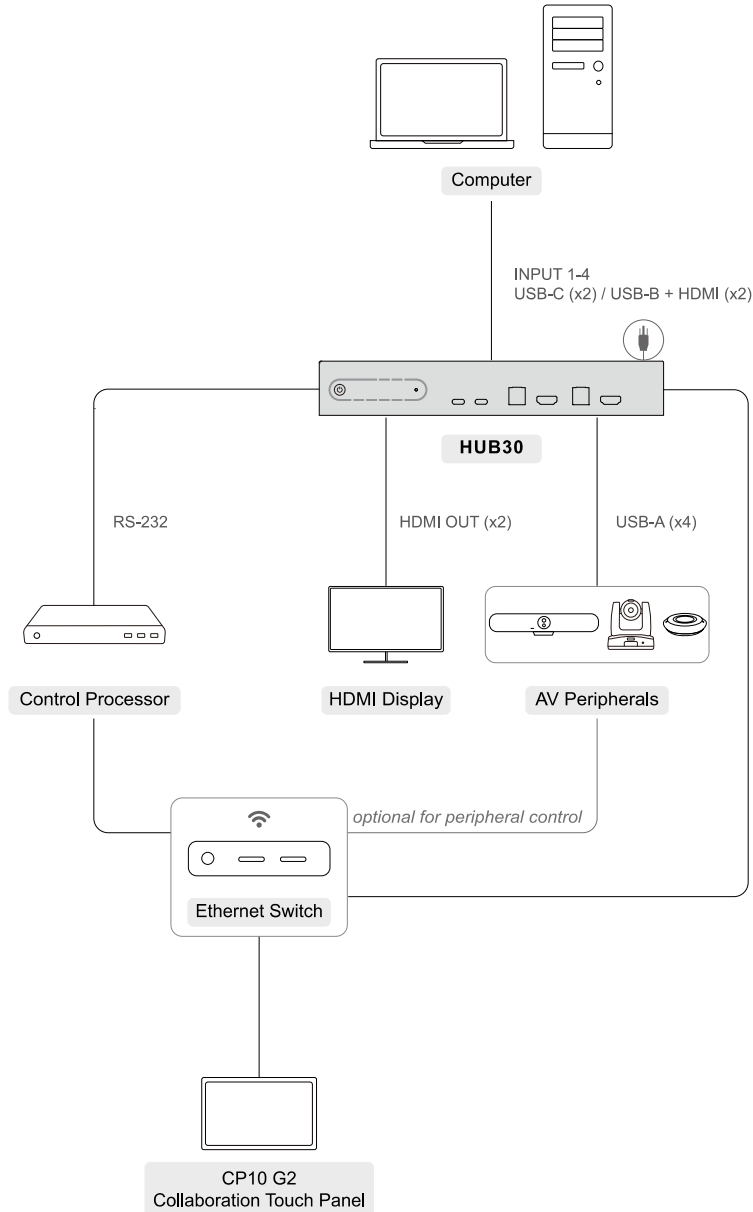

RS-232 Pinout

The device provides a 3-pole Phoenix[®] connector for bi-directional serial communication. The signal levels are the following:

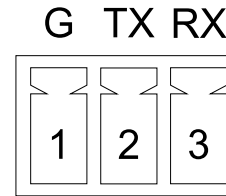

	Output voltage (V)
Logic low level	3 to15
Logic high level	-15 to -3

Access the Web Interface

To access the web interface of your device, you can use AVer Device Utility to find its IP address:

1. Download and install AVer Device Utility to your computer from AVer Download Center (<https://www.aver.com/download/device-utility>) and launch the software.
2. Click **Search** to see available devices on the same local area network (LAN).

Note:

 - Make sure your device is connected to the internet.
 - AVer Device Utility and your device must be on the same LAN.
3. Double-click on your device's IP address in the **IPv4 Address** column to open the web interface in your browser.
4. When you log in for the first time, enter the default username and password **admin/admin**. You will be prompted to set up a new username and password. The account and password cannot be the same.

Note:

- The device's default network is DHCP.
- If the DHCP server fails to assign an IP after several attempts, the device defaults to 192.168.1.168. Multiple devices will be assigned random IPs within 192.168.1.1 - 192.168.1.254.
- To troubleshoot, make sure your DHCP server is running. Then disconnect and reconnect the LAN cable.

Factory Reset Settings

IP address	DHCP
Hostname	<ul style="list-style-type: none">[Model name]-[last 6 digits of MAC Address] <i>Example: HUB30-3a8292</i>Find the MAC address on the bottom or rear of the device.
Web interface login	admin/admin
Display control	Disabled
Input/output source mode	Single - Duplicate

* For the complete and updated factory reset settings, please refer to the user manual.

Federal Communication Commission Interference Statement

NOTE: This equipment has been tested and found to comply with the limits for a Class A digital device, pursuant to part 15 of the FCC Rules. These limits are designed to provide reasonable protection against harmful interference when the equipment is operated in a commercial environment. This equipment generates, uses, and can radiate radiofrequency energy and, if not installed and used in accordance with the instruction manual, may cause harmful interference to radio communications. Operation of this equipment in a residential area is likely to cause harmful interference in which case the user will be required to correct the interference at his own expense. FCC Caution: Any changes or modifications not expressly approved by the party responsible for compliance could void the user's authority to operate this equipment.

This device complies with part 15 of the FCC Rules.

The Operation is subject to the following two conditions:

- (1) This device may not cause harmful interference, and
 - (2) this device must accept any interference received, including interference that may cause undesired operation.
- This Class A digital apparatus complies with Canadian ICES-003. Cet appareil numérique de la classe A est conforme à la norme NMB-003 du Canada.

Warning

This is a class A product. In a domestic environment this product may cause radio interference in which case the user may be required to take adequate measures.

PSTI Statement of Compliance

Please refer to the following website: <https://www.aver.com/product-security-advisory>

Caution

Risk of explosion if battery is replaced by an incorrect Type. Dispose of used batteries according to the Instructions.

VCCI-A

この装置はクラス A 機器です。この装置を住宅環境で使用すると電波妨害を引き起こすことがあります。この場合には使用者が適切な対策を講ずるよう要求されることがあります。

(注) 本製品同梱の電源ケーブルは本製品同梱の電源アダプタでのみ使用してください。本製品同梱の電源ケーブルは他の電気機器では使用できません。

사 용 자 안 내 문	
이 기기는 업무용 환경에서 사용할 목적으로 적합성평가를 받은 기기로서 가정용 환경에서 사용하는 경우 전자파간섭의 우려가 있습니다.	
※ 사용자 안내문은 "업무용 방송통신기자재"에만 적용됩니다.	

기종별	사용자안내문
A 급 기기 (업무용 방송통신기자재)	이 기기는 업무용(A 급) 전자파적합기기로서 판매자 또는 사용자는 이 점을 주의하시기 바라며, 가정외의 지역에서 사용하는 것을 목적으로합니다.

COPYRIGHT

© 2025 AVer Information Inc. All rights reserved. | June 10, 2025

The information contained in this documentation is subject to change without notice.

Contact Information

Headquarters

AVer Information Inc.
8F, No.157, Da-An Rd., Tucheng
Dist., New Taipei City 23673,
Taiwan
Tel: +886 (2) 2269 8535

Japan Branch Office

アバー・インフォメーション株式会社
〒160-0023 日本東京都新宿区西新宿
3-2-26 立花新宿ビル 7 階
Tel: +81 (0) 3 5989 0290
お客様サポートセンター(固定電話のみ): +81 (0) 120 008 382

USA Branch Office

AVer Information Inc., Americas
44061 Nobel Drive, Fremont, CA
94538, USA
Tel: +1 (408) 263 3828
Toll-free: +1 (877) 528 7824

Vietnam Branch Office

Công ty TNHH AVer Information
(Việt Nam)
Tầng 5, 596 Nguyễn Đình Chiểu,
P.3, Quận 3, Thành phố Hồ Chí
Minh 700000, Việt Nam
Tel: +84 (0) 28 22 539 211
Hỗ trợ kỹ thuật: +84 (0) 90 70 080
77

Europe Branch Office

AVer Information Europe B.V.
Westblaak 134, 3012 KM,
Rotterdam, The Netherlands
Tel: +31 (0) 10 7600 550

Korea Office

한국 에버 인포메이션 (주)
서울시 종로구 새문안로 92
(신문로 1 가,
광화문오피시아빌딩) 1831,
1832 호
Tel: +82 (0) 2 722 8535

