

AVer AmpliWave Go Portable Audio System

— **User Manual** —

Federal Communication Commission Interference Statement

This device complies with Part 15 of the FCC Rules. Operation is subject to the following two conditions: (1) This device may not cause harmful interference, and (2) this device must accept any interference received, including interference that may cause undesired operation.

This equipment has been tested and found to comply with the limits for a Class B digital device, pursuant to Part 15 of the FCC Rules. These limits are designed to provide reasonable protection against harmful interference in a residential installation. This equipment generates, uses and can radiate radio frequency energy and, if not installed and used in accordance with the instructions, may cause harmful interference to radio communications. However, there is no guarantee that interference will not occur in a particular installation. If this equipment does cause harmful interference to radio or television reception, which can be determined by turning the equipment off and on, the user is encouraged to try to correct the interference by one of the following measures:

- Reorient or relocate the receiving antenna.
- Increase the separation between the equipment and receiver.
- Connect the equipment into an outlet on a circuit different from that to which the receiver is connected.
- Consult the dealer or an experienced radio/TV technician for help.

FCC Caution: Any changes or modifications not expressly approved by the party responsible for compliance could void the user's authority to operate this equipment.

This Class B digital apparatus complies with Canadian ICES-003.
Cet appareil numérique de la classe B est conforme à la norme NMB-003 du Canada.

FOR MOBILE DEVICE USAGE (>20cm/low power eg. AP routers)

Radiation Exposure Statement:

This equipment complies with FCC radiation exposure limits set forth for an uncontrolled environment. This equipment should be installed and operated with minimum distance 20cm between the radiator & your body.

IC Notice:

This device complies with RSS-247 of the Industry Canada Rules. Operation is subject to the following two conditions: (1) This device may not cause harmful interference, and (2) this device must accept any interference received, including interference that may cause undesired operation.

Ce dispositif est conforme à la norme CNR-247 d'Industrie Canada applicable aux appareils radio exempts de licence. Son fonctionnement est sujet aux deux conditions suivantes: (1) le dispositif ne doit pas produire de brouillage préjudiciable, et (2) ce dispositif doit accepter tout brouillage reçu, y compris un brouillage susceptible de provoquer un fonctionnement indésirable.

Europe – EU Declaration of Conformity

This device complies with the essential requirements of the Radio Equipment Directive (2014/53/EU). The following test methods have been applied in order to prove presumption of conformity with the essential requirements of the Radio Equipment Directive (2014/53/EU)

Earthing Connection

The power cord shall be connected to a socket outlet with earthing connection.

DISCLAIMER

No warranty or representation, either expressed or implied, is made with respect to the contents of this documentation, its quality, performance, merchantability, or fitness for a particular purpose. Information presented in this documentation has been carefully checked for reliability; however, no responsibility is assumed for inaccuracies. The information contained in this documentation is subject to change without notice.

In no event will AVer Information Inc. be liable for direct, indirect, special, incidental, or consequential damages arising out of the use or inability to use this product or documentation, even if advised of the possibility of such damages.

TRADEMARKS

“AVer” is a trademark owned by AVer Information Inc. Other trademarks used herein for description purpose only belong to each of their companies.

COPYRIGHT

©2025 AVer Information Inc. All rights reserved. | January 6, 2025

All rights of this object belong to AVer Information Inc. Reproduced or transmitted in any form or by any means without the prior written permission of AVer Information Inc. is prohibited. All information or specifications are subject to change without prior notice.

More Help

For FAQs, technical support, software and user manual download, please visit:

Non-USA

Download Center: <https://www.aver.com/download-center>

Technical Support: <https://www.aver.com/technical-support>

USA

Download Center: <https://www.averusa.com/education/support/>

Technical Support: <https://www.averusa.com/education/support/>

Contact Information

Headquarters

AVer Information Inc.
8F, No.157, Da-An Rd., Tucheng Dist.,
New Taipei City 23673, Taiwan
Tel: +886 (2) 2269 8535

USA Branch Office

AVer Information Inc., Americas
44061 Nobel Drive, Fremont, CA 94538, USA
Tel: +1 (408) 263 3828
Toll-free: +1 (877) 528 7824

Europe Branch Office

AVer Information Europe B.V.
Westblaak 134, 3012 KM, Rotterdam, The
Netherlands
Tel: +31 (0) 10 7600 550

Japan Branch Office

アバー・インフォメーション株式会社
〒160-0023 日本東京都新宿区西新宿 3-2-26
立花新宿ビル 7 階
Tel: +81 (0) 3 5989 0290
お客様サポートセンター(固定電話のみ): +81 (0)
120 008 382

Vietnam Branch Office

Công ty TNHH AVer Information (Việt Nam)
Tầng 5, 596 Nguyễn Đình Chiểu,
P.3, Quận 3,
Thành phố Hồ Chí Minh 700000, Việt Nam
Tel: +84 (0) 28 22 539 211
Hỗ trợ kỹ thuật: +84 (0) 90 70 080 77

Korea Office

한국 에버 인포메이션 (주)
서울시 종로구 새문안로 92
(신문로 1 가, 광화문오피시아빌딩) 1831,
1832 호
Tel: +82 (0) 2 722 8535

Contents

Overview	1
PACKAGE CONTENTS.....	1
OPTIONAL ACCESSORIES	1
PARTS INFO.....	2
DIMENSION.....	3
Device Setup	4
RECOMMENDED PLACEMENT.....	4
Installation	5
WALL MOUNT (OPTIONAL ACCESSORIES).....	5
TRIPOD STAND (OPTIONAL ACCESSORIES).....	6
Controls and Interface	7
TOP PANEL.....	7
BACK PANEL.....	9
LCD SCREEN HOME PAGE	10
Connecting and Using Your Device	11
WIRELESS MICROPHONE CONNECTION	11
Pair up Your Microphone.....	11
Use Your Microphone.....	12
Charge Your Microphone.....	13
Replace Your Microphone Battery.....	14
BLUETOOTH® CONNECTION.....	15
USB FLASH DRIVE	16
USB TYPE-C CONNECTION	16
3.5 MM AUDIO JACK	17
Recording	18

Settings	19
Specifications	20
Troubleshooting	22
PORTABLE SPEAKER	22
WIRELESS MICROPHONE	23

Overview

Package Contents

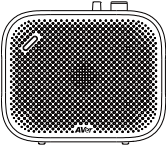

AmpliWave Go
Portable Speaker



SAT5 Pendant
Wireless
Microphone

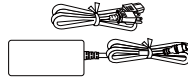

Power Adapter &
Power Cord

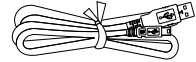

USB 2.0 Type-C to
Type-A Cable
(1.5m)*



Lanyard



QR Code Card

*For SAT5 pendant wireless microphone charging only.

Optional Accessories



Tripod Stand



Wall Mount Bracket

Parts Info

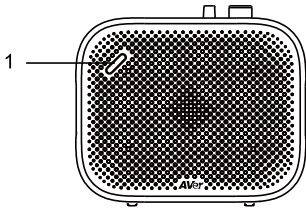

Front View

1. Built-in RX Microphone Receiver*

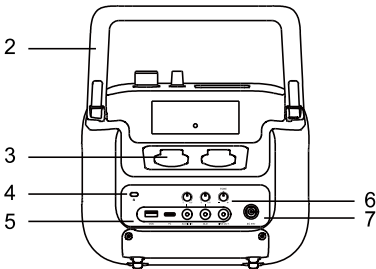

Back View

2. Handle
3. Microphone Charging Slots
4. Kensington Lock
5. I/O Ports:
USB Port / USB Type-C Port / Audio IN / ALD / Line Out
6. Audio Input and Control Knobs
7. DC 19V Power Jack

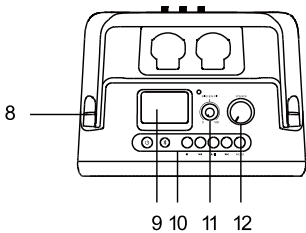

Top View

8. Buckle Ring
9. LCM Screen
10. Control Buttons:
Power / Bluetooth® / Recording / Previous / Pause & Play / Next / Menu
11. Wireless Microphone Volume Knob
12. Speaker Volume Knob

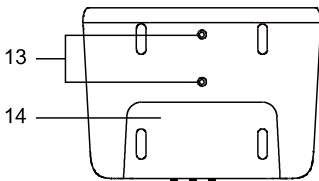

Bottom View

13. Wall Mount & Tripod Screw Holes
14. Built-in Battery*

*The built-in accessories should be replaced by its manufacturer, service technician, or a similarly qualified person.

Dimension

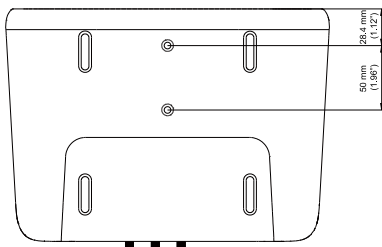
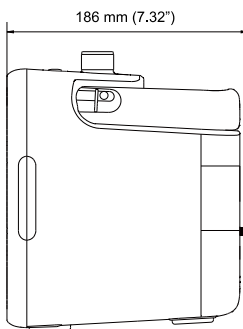
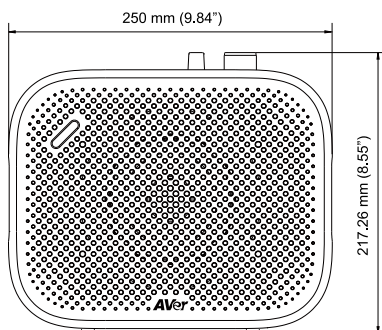

Device Setup

Recommended Placement

For optimal performance, we recommend installing AmpliWave Go on the left or right wall of the classroom, or placing it on a shelf. Additionally, make sure that your microphone is positioned higher or lower than the AmpliWave Go unit to prevent reverberation.

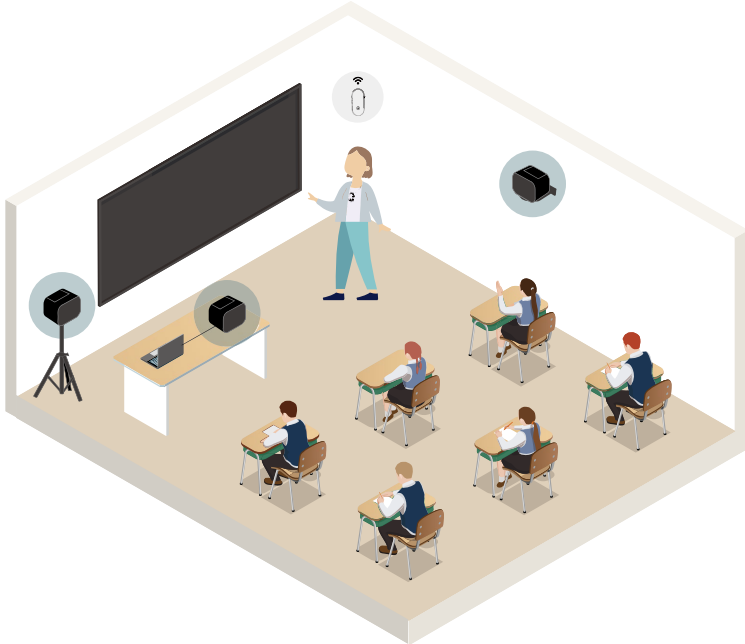

- Use the AmpliWave Go handle or attach a carrying strap (not included) to the buckle rings for easy portability. Place the AmpliWave Go on a flat, stable surface and avoid exposing it to water.
- Ensure the device is fully charged for up to 8 hours of playback. To fully charge the device, use the included adapter for approximately 4 hours.

Installation

Wall Mount (Optional Accessories)

Reserve a minimum distance of 2 m (7-8 ft.) from the floor for wall mount installation.

1. Use the wall mount drill template to mark and drill 4 holes on the wall.
2. Secure the bracket to the wall with four M3*18 mm screws.

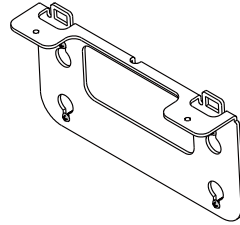
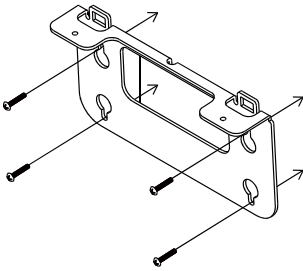

3. Secure the top bracket to the lower bracket with two M4*8 mm screws.

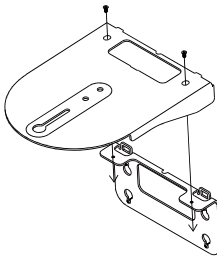

4. Locate your AmpliWave Go to the top bracket, and secure the device with one 1/4"-20 screw from the bottom.

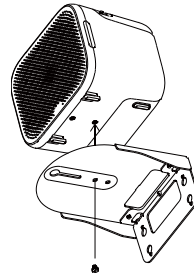

5. Make sure all screws are secured tightly.

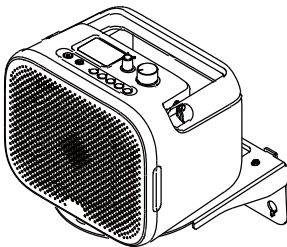

Tripod Stand (Optional Accessories)

When using a tripod, make sure to:

1. Place the tripod on a flat floor, and fully extend the tripod legs.
2. Install and fully secure AmpliWave Go to the tripod.

Controls and Interface

Top Panel

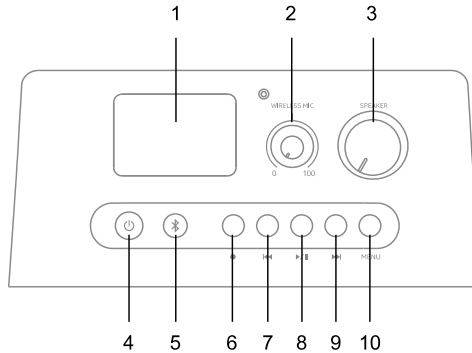

Name	Description										
1. LCM Screen	View and configure device settings and status.										
2. Wireless Microphone Volume Knob	Adjust the wireless microphone volume level.										
3. Main Speaker Volume Knob	Adjust the speaker volume level.										
4. Power	Press and hold for 5 seconds to power up and off. <table border="1" data-bbox="392 1005 972 1252"> <thead> <tr> <th>LED</th> <th>Status</th> </tr> </thead> <tbody> <tr> <td>Flashing Green </td> <td>Start-up</td> </tr> <tr> <td>Solid Green </td> <td>Power up</td> </tr> <tr> <td>Flashing Red </td> <td>Firmware updating</td> </tr> <tr> <td>Solid Red </td> <td>Charging when power off</td> </tr> </tbody> </table>	LED	Status	Flashing Green	Start-up	Solid Green	Power up	Flashing Red	Firmware updating	Solid Red	Charging when power off
LED	Status										
Flashing Green	Start-up										
Solid Green	Power up										
Flashing Red	Firmware updating										
Solid Red	Charging when power off										
5. Bluetooth®	Press to pair with mobile devices, Bluetooth® speakers or other Bluetooth® enabled devices. <table border="1" data-bbox="392 1321 972 1412"> <thead> <tr> <th>LED</th> <th>Status</th> </tr> </thead> <tbody> <tr> <td>Off</td> <td>Disconnected or pairing timeout</td> </tr> </tbody> </table>	LED	Status	Off	Disconnected or pairing timeout						
LED	Status										
Off	Disconnected or pairing timeout										

	Flashing Blue ★	Pairing
	Solid Blue ●	Pairing completed
	<p>Note: Bluetooth® effective range: 10 m (30 ft.) line of sight.</p>	
6. ● Recording	Press to start recording on AmpliWave Go. Press again to stop and save recordings to your USB flash drive. See < Recording > for more details.	
7. ⏮ Previous	<ul style="list-style-type: none"> • Press to restart the current track. • Double-press to play the previous track. • Press and hold to rewind the current track. 	
8. ▶⏸ Play / Pause	Press to play or pause audio.	
9. ▶▶ Next	<ul style="list-style-type: none"> • Press to play the next track. • Press and hold to fast forward the current track. 	
10. Menu	Press to view and configure settings.	

Back Panel

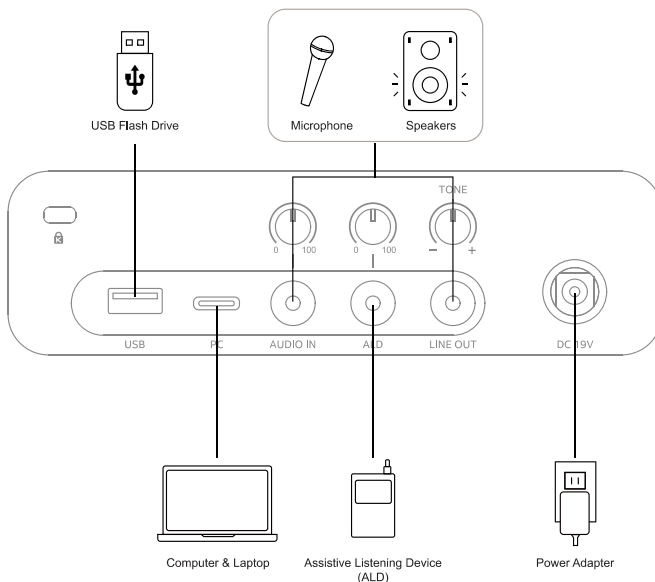

Name	Description
USB Port	Insert a USB flash drive (Max. 32GB, FAT32) to play sound tracks or save recordings.
PC Port	Connect your AmpliWave Go to a computer or a laptop using a USB Type-C to Type-A cable (not included).
Audio Input Port	Connect an external microphone to your device for audio transmission using a 3.5 mm cable (not included).
Audio In Knob	Turn Audio In volume knob to adjust the microphone volume.
ALD Port	Connect an Assisted Listening Device (ALD) to the ALD port for use with hearing aids.
ALD Volume Knob	Turn the ALD volume knob to adjust the ALD volume.
Line Out Port	Connect to an external audio device for simultaneous audio output or recording using a 3.5 mm cable (not included).
Tone Knob	Turn the tone knob to bass up or down.
DC 19V	Connect the power adapter to a power outlet. Press and hold  to power up and off.

LCD Screen Home Page



1. Connection Status Bar

Display microphone, Bluetooth®, USB flash drive and speaker connection status.

2. Battery Status Bar

Display battery status of the wireless microphones and AmpliWave Go.

3. Main Screen

User interface screen display.

Connecting and Using Your Device

AmpliWave Go supports multiple connectivity options to play audio. Select a playback mode before you start, and follow the instructions to pair up your devices.

Wireless Microphone Connection

The SAT5 Pendant Microphone will automatically connect to the built-in RX receiver on AmpliWave Go after it is powered on.

Pair up Your Microphone

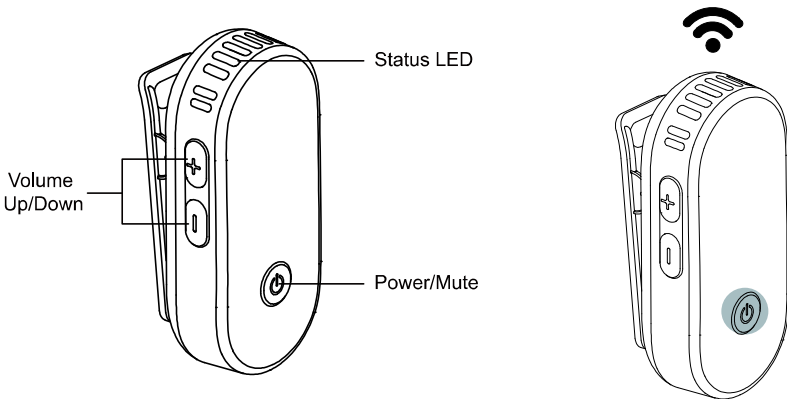

1. Press and hold the Power/Mute button on the microphone for 3 seconds to power it on. The microphone status LED will appear solid green ●.
2. The microphone will automatically connect to AmpliWave Go after the device powers up. The microphone must be within about 20 m (65 ft.) of the AmpliWave Go to pair.
3. When pairing is completed, the microphone status LED will appear solid blue ●, and you will see the microphone battery status on the LCD screen.
 - If the microphone signal is not transmitting to the receiver or goes out of range, the microphone status LED will flash blue ★.

Use Your Microphone

Please follow the instructions below for optimal audio quality.

1. Tuck the lanyard through the hook and pull hard to secure the lanyard. Then wear it around your neck.
2. Adjust the lanyard to position the microphone approximately 15 cm (5.9") from your mouth.

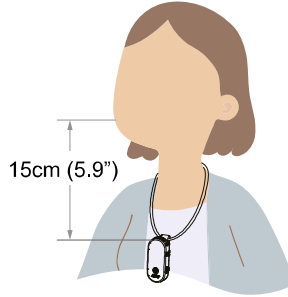
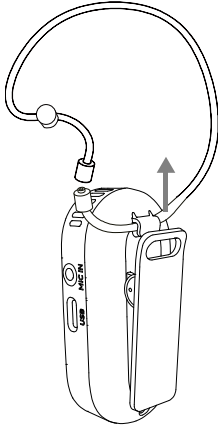

3. Press the Volume Up/Down buttons to adjust volume, or press the Power/Mute button to mute. When muted, the status LED will appear solid red ●.
4. The microphone will automatically turn off:
 - When it is out of range or after 3 minutes of attempting to connect.
 - After being muted for 30 minutes.

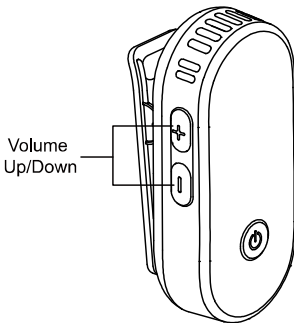

Charge Your Microphone

When the microphone battery is running low, the status LED will flash red ★.

To charge your microphone, you may:

- Plug your microphone into the AmpliWave Go charging slot.
- Plug your microphone into a power source using the included USB Type-C to Type-A cable.

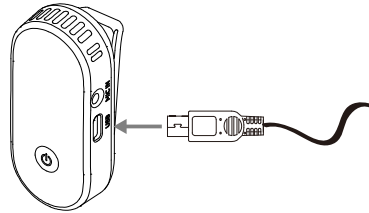
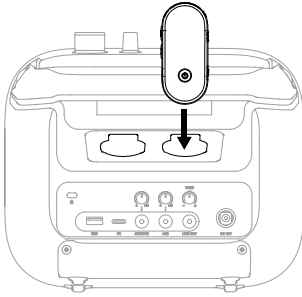

During charging, the status LED will appear solid red ●, and will change to solid green ● once fully charged, which takes approximately 3 hours.

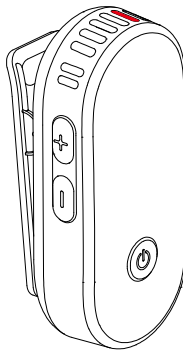

Tips:

- A single charge provides 8-10 hours of talk time.
- A 10-minute charge provides 1 hour of talk time.

Replace Your Microphone Battery

The battery should be replaced by its manufacturer, service technician, or a similarly qualified person.

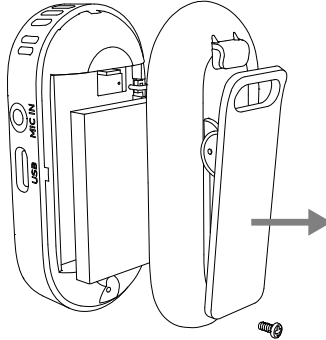

1. Turn off the microphone. Loosen the screw and open the battery door
2. Remove the battery by gently pulling up from the notch on the bottom.
3. Insert the replacement battery, close the battery door, and tighten the screw.

Bluetooth® Connection

Make sure your AmpliWave Go is powered on and the Bluetooth® setting on your mobile device is in discovery mode.

1. Press and hold the Bluetooth® button on AmpliWave Go for 3 seconds to activate pairing. Your mobile device must be within about 10 m (30 ft.) of the AmpliWave Go to pair.
2. Select AmpliWave Go Bluetooth® name: “**AVer AWM Go xxxx**” (a 4-digit number) on your mobile phone or computer. To check the 4 digit number, press the **Menu** button and the **▶▶ Next** button to navigate the menu > press **▶▶ Play / Pause** button to enter the **Information** page.
3. During pairing, the Bluetooth® button will flash blue *****. When pairing is completed, an audio cue will play to confirm successful pairing, and the Bluetooth® button LED will change to solid blue **●**.



4. Select and play tracks directly from your mobile device. Use the control buttons and knobs to control playback, volume and audio tone.

Note:

- AmpliWave Go can remember up to 2 paired devices and will automatically connect when Bluetooth® is on.
- If a third device is paired, it will overwrite the pairing memory of the first device.

To disconnect from all paired devices:

Press and hold the Bluetooth® button for 3 seconds, and repeat the pairing process with new devices.

USB Flash Drive



1. Insert your FAT32 formatting USB flash drive into the AmpliWave Go USB port to play audio files or save recordings. AmpliWave Go automatically loads the first audio track in the folder.
2. Use the control buttons and knobs to control playback and volume.

Note:

- The audio files on your USB flash drive should be saved in the “**AVER_AUD**” folder.
- Supported audio file format: mp3, and WAV.
- Only English letters and numbers are supported in audio filenames.

USB Type-C Connection

AmpliWave Go supports both hybrid and hyflex learning. During an online course, you can hear audio from the remote site on both your computer’s speaker and AmpliWave Go.

1. Connect your computer to AmpliWave Go using a USB Type-C to Type-A cable (not included) to output computer audio through AmpliWave Go.
2. Open your video conferencing software, such as Google Meet, Skype, Microsoft Teams or Zoom, and select “AVer AmpliWave Go” as the microphone and speaker source.
3. Open **Audio System Settings** page on your computer, and select “AVer AmpliWave Go” as the audio input and output device.

3.5 mm Audio Jack

- **Audio In**

1. Connect to an external microphone, mobile phone, laptop or other audio devices using a 3.5 mm audio cable (not included).
2. Based on the connected device, press the **Menu** button and select **Audio Input Source**, and then press the  **Play / Pause** button to switch audio input source between **LINE in** or **MIC in**.
3. Use the Audio In Knob on the back panel to adjust the volume of the audio input source.

- **Line Out**

Connect to an external speaker or other audio output devices using a 3.5 mm audio cable (not included) for simultaneous audio output.

Recording

Before recording, insert your USB flash drive to AmpliWave Go. You can record using a wireless microphone, Bluetooth®-connected device, or an audio device with recording capabilities connected to the 3.5mm audio-in port.



1. Insert a USB flash drive to the AmpliWave Go USB port, and connect to an external audio source with recording capabilities.
2. Press the **• Recording** button to start recording. The LCD screen will display the recording status and duration.
3. To finish recording, press the **• Recording** button to stop and save the audio file. The recordings will automatically saved in the "AVER_AUD" folder on your USB flash drive. File names follow the format: **AVERXXXX.mp3** (a 4-digit number indicating the recording sequence).

Note:

- The maximum recording time per file is 1 hour. When the limit is reached, a new file will be created automatically.
- Recording will stop if the previous file is named AVER9999.MP3, and a notification message will be displayed.

Settings

From the home page, press the **Menu** button to enter the Setting page. Press the **◀ Previous** or the **▶ Next** button to navigate the menu, and press **▶/|| Play / Pause** to toggle a switch or confirm a selection. Press the **Menu** button again to return to the home page.

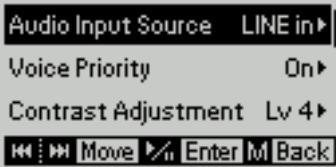

Item	Description
Audio Input Source	Switch the audio input source between LINE in and MIC in .
Voice Priority	Turn on this function to increase the microphone volume when multiple audio sources are playing through the AmpliWave Go simultaneously.
Contrast Adjustment	Adjust the LCD screen display contrast from Lv 1 to Lv 4.
Power Saving Mode	Turn the function on to save the AmpliWave Go battery life for longer use.
Information	<p>Check the firmware version and Bluetooth® name.</p> <p>To update firmware:</p> <ol style="list-style-type: none"> 1. Download firmware update file from AVer Download Center. 2. Create a new folder named: "AVerUpdate" on your USB flash drive to save the .dat update file. 3. Insert the USB to the USB port, and follow the on-screen instruction to update firmware. When finished, wait for the device to reboot.
Language	Select the language to be displayed on the LCD screen.
Factory Default	Reset to settings to factory default.

Specifications

System	Power requirement	19 V / 3.42 A, 65 W
	Output power	30 watts
	Battery type	Rechargeable 40Wh (at least) & removable
	Battery life	Depends on track type and volume. Provides up to 8 hours of operation under typical conditions. (fully charged, 1 mic + 1 audio in).
	Battery specification	Brand: TBCS, model: AV0401A 14.4V, 3350mAh/48.24 Wh
	Charge time	Less than 4 hours (from 0% to 100%)
	Built-in microphone charger	Yes, up to 2 microphones
	Frequency response	120-20 KHz \pm 3 dB
	Signal-to-Noise ratio	70 dB or more
	Dimensions (W x H x D)	250 x 220 x 180 mm
	Weight with battery	6.6 lbs (3kg)
	FCC ID	2AHDGAMWGO
	IC ID	21367-AMWGO
Audio In and Out	Audio input	1 x 3.5 mm stereo (Mic In & Line In) 1 x USB-A USB flash drive 1 x USB-A wireless microphone RX 1 x Bluetooth®
	Audio output	1 x 3.5 mm stereo (ALD) 1 x 3.5 mm stereo (Line Out)
	Audio input / output	USB 2.0 Type-C: PC / Laptop
Connectivity and Communication	Wireless communication	2.4 GHz proprietary for microphone RX
	Operating range	20 m (65 ft.)
	Bluetooth communication	Bluetooth version 5.4
	Bluetooth profiles	A2DP

	Bluetooth communication range	10 m (30 ft.) line of sight	
	Bluetooth pairing method	Manual / auto	
Interface and Control	Power button	Flashing Green ★	Start-up
		Solid Green ●	Power up
		Flashing Red ★	Firmware updating
		Solid Red ●	Charging when power off
	Handle	built-in handle	
	Digital display	Yes, black and white	
	Master volume control	Gain knob x 1	
	Recording / playing buttons	Recording / playing buttons x 5 (recording, previous, pause / play, next, menu)	
	Gain knobs	Gain knobs x 4 (Audio in, wireless mic, headphone out, tone)	
	Voice priority	On / Off	
Pairing button	Yes		
Kensington lock	Kensington lock x 1		
Environmental	Working temp.	0°C-35°C	
	Working RH	10%-90%	
	Storage temp.	-30°C-60°C	
	Storage RH	10%-90%	
Warranty and package contents	Product	<ul style="list-style-type: none"> • AMW Go Portable speaker with a built-in SAC5 wireless microphone receiver • SAT5 wireless microphone 	
	Accessories	<ul style="list-style-type: none"> • Power cable 1.8 m x 1 • Power adapter 65 W 1.5 m x 1 • QR Code card x 1 • Lanyard x 1 • USB 2.0 Type-C to Type-A cable (1.5 m) 	
	Warranty	AMW Go Portable Speaker: 5 years Battery and accessories: 1 year	

Troubleshooting

Portable Speaker

I can't turn on my AmpliWave Go.

The battery may be depleted.

Connect your AmpliWave Go to the power adapter and plug it into a power outlet to charge.

The LED status will appear solid red ● to show charging.

I can't pair with my mobile device through Bluetooth® connection.

1. Reconnect your mobile device and AmpliWave Go:
 - On your mobile device, go to the Bluetooth® settings, tap "**Forget Device**" to unpair the AmpliWave Go, then turn Bluetooth® off and on to reset the connection.
 - On AmpliWave Go, press and hold the Bluetooth® button for 3 seconds to clear all paired devices. Then, attempt to reconnect.
2. Make sure the following:
 - Your mobile device is within the AmpliWave Go Bluetooth® effective range of about 10 m (30 ft.) and free of interference or obstacles.
 - AmpliWave Go can only pair and operate with one device through Bluetooth® connection at a time.
3. If the issue persists, try rebooting AmpliWave Go.

There is no audio or the volume is too low (Bluetooth® connection).

1. Use the master volume knobs on AmpliWave Go to adjust the speaker volume.
2. Make sure your connected device is powered on, and slightly increase the volume on your mobile device or audio source.
3. If two mobile devices are connected through the Bluetooth®, unpair one device, or press and hold the Bluetooth® button for 3 seconds to disconnect all paired devices and reconnect.

There is no audio or the volume is too low (3.5 mm audio jack connection).

1. Make sure the connected audio input device is powered on.
2. Secure the 3.5 mm cable into the AmpliWave Go Audio In port.
3. On AmpliWave Go, press the **Menu** button to check and select the correct **Audio Input Source**.
4. Use the master volume knob and audio in volume knob to slightly increase the volume.
5. If the issue persists:
 - Try using another 3.5 mm cable.
 - Connect another audio input device and try again.

Wireless Microphone

I can't pair the wireless microphone with AmpliWave Go.

- Make sure both your AmpliWave Go and the wireless microphone are powered on. The LED status should appear solid green ● on both devices.
- Press and hold the Power / Mute button to power it off, and press it again to power back on.
- Make sure the wireless microphone is within the effective pairing range of about 20 m (65 ft.) of AmpliWave Go.

There is no audio or the volume is too low.

- Make sure your wireless microphone is not muted. When muted, the microphone LED status will appear solid red ●. Press and hold the Power / Mute button to unmute.
- Adjust the microphone volume using the volume up/down buttons on the side of the microphone.
- Position the microphone approximately 15 cm (5.9 inches) from your mouth for optimal audio quality.

I hear feedback or squealing.

- The volume may be too high. Lower the volume using the volume up/down buttons on the side of the microphone.
- The microphone may be too close to the speaker. Move the microphone away from the speaker to reduce feedback.