

VC520 Pro2

User Manual



Federal Communications Commission Statement

NOTE: This equipment has been tested and found to comply with the limits for a Class A digital device, pursuant to part 15 of the FCC Rules. These limits are designed to provide reasonable protection against harmful interference when the equipment is operated in a commercial environment. This equipment generates, uses, and can radiate radiofrequency energy and, if not installed and used in accordance with the instruction manual, may cause harmful interference to radio communications. Operation of this equipment in a residential area is likely to cause harmful interference in which case the user will be required to correct the interference at his own expense.

FCC Caution: Any changes or modifications not expressly approved by the party responsible for compliance could void the user's authority to operate this equipment.

This device complies with part 15 of the FCC Rules.

Operation is subject to the following two conditions:

- (1) This device may not cause harmful interference, and
- (2) this device must accept any interference received, including interference that may cause undesired operation.

Warning:

This is a class A product. In a domestic environment this product may cause radio interference in which case the user may be required to take adequate measures.

This Class A digital apparatus complies with Canadian ICES-003. Cet appareil numérique de la classe A est conforme à la norme NMB-003 du Canada.

この装置は、クラス A 機器です。この装置を住宅環境で使用すると電波妨害を引き起こすことがあります。この場合には使用者が適切な対策を講ずるよう要求されることがあります。

VCCI-A

사 용 자 안 내 문	
이 기기는 업무용 환경에서 사용할 목적으로 적합성평가를 받은 기기로서 가정용 환경에서 사용하는 경우 전자파간섭의 우려가 있습니다.	
※ 사용자 안내문은 "업무용 방송통신기자재"에만 적용됩니다.	

기종별	사용자안내문
A 급 기기 (업무용 방송통신기자재)	이 기기는 업무용(A 급) 전자파적합기기로서 판매자 또는 사용자는 이 점을 주의하시기 바라며, 가정외의 지역에서 사용하는 것을 목적으로 합니다.

DISCLAIMER

No warranty or representation, either expressed or implied, is made with respect to the contents of this documentation, its quality, performance, merchantability, or fitness for a particular purpose. Information presented in this documentation has been carefully checked for reliability; however, no responsibility is assumed for inaccuracies. The information contained in this documentation is subject to change without notice.

In no event will AVer Information Inc. be liable for direct, indirect, special, incidental, or consequential damages arising out of the use or inability to use this product or documentation, even if advised of the possibility of such damages.

TRADEMARKS

“AVer” is a trademark owned by AVer Information Inc. Other trademarks used herein for description purpose only belong to each of their companies.

COPYRIGHT

©2022 AVer Information Inc. All rights reserved. | May 6, 2022

All rights of this object belong to AVer Information Inc. Reproduced or transmitted in any form or by any means without the prior written permission of AVer Information Inc. is prohibited. All information or specifications are subject to change without prior notice.

NOTICE

- SPECIFICATIONS ARE SUBJECT TO CHANGE WITHOUT PRIOR NOTICE. THE INFORMATION CONTAINED HEREIN IS TO BE CONSIDERED FOR REFERENCE ONLY.
- THE CONTENTS ARE SUBJECT TO CHANGE WITHOUT PRIOR NOTICE. IF THE CONTENT IS WRONG, PLEASE INFORM US TO MAKE CORRECTIONS.

WARNING

- To reduce risk of fire or electric shock, do not expose this appliance to rain or moisture. Warranty will be void if any unauthorized modifications are done to the product.
- Do not drop the camera or subject it to physical shock.
- Use correct power supply voltage to avoid damaging camera.
- Do not place the camera where the cord can be stepped on as this may result in fraying or damage to the lead or the plug.
- Hold the bottom of the camera with both hands to move the camera. Do not grab the lens or lens holder to move the camera.

Remote Control Battery Safety Information

- Store batteries in a cool and dry place.
- Do not throw away used batteries in the trash. Properly dispose of used batteries through specially approved disposal methods.
- Remove the batteries if they are not in use for long periods of time. Battery leakage and corrosion can damage the remote control. Dispose of batteries safely and through approved disposal methods.
- Do not use old batteries with new batteries.
- Do not mix and use different types of batteries: alkaline, standard (carbon-zinc) or rechargeable (nickel-cadmium).
- Do not dispose of batteries in a fire.
- Do not attempt to short-circuit the battery terminals.

CAUTION

- Risk of explosion if battery is replaced by an incorrect type.
- Dispose of used batteries in a safe and proper manner.

遥控器电池安全信息

- 请将电池存放在凉爽与干燥的位置。
- 不要将电量用尽的电池弃置在家庭废弃物中。请将电池弃置在特定回收处,或送回原购买的商店。
- 如果长时间不使用电池,请将其取出。电池漏液与腐虫可能会损坏遥控器,请以安全方式弃置电池。
- 不可混用新旧电池。
- 不可混用不同类型的电池:碱性、标准(碳锌)或可充电(镍镉)电池。
- 不可将电池弃置于火源中。
- 请勿尝试让电池端子短路。

More Help

For FAQs, technical support, software and user manual download, please visit:

Headquarters

Download Center: <https://www.aver.com/download-center>
Technical Support: <https://www.aver.com/technical-support>

USA Branch office

Download Center: <https://www.averusa.com/business/support/>
Technical Support: <https://averusa.force.com/support/s/contactsupport>

Europe Branch office

Download Center: <https://www.avereurope.com/download-center>
Technical Support: <https://www.avereurope.com/technical-support>

Contact Information

Headquarters

AVer Information Inc.

<https://www.aver.com>

8F, No.157, Da-An Rd., Tucheng Dist., New Taipei City 23673, Taiwan

Tel: +886 (2) 2269 8535

USA Branch office

AVer Information Inc., Americas

<https://www.averusa.com>

668 Mission Ct., Fremont, CA 94539, USA

Tel: +1 (408) 263 3828

Toll-free: +1 (877) 528 7824

Technical support: support.usa@aver.com

Europe Branch office

AVer Information Europe B.V.

<https://www.avereurope.com>

Westblaak 134, 3012 KM, Rotterdam, The Netherlands

Tel: +31 (0) 10 7600 550

Technical support: eu.rma@aver.com

Japan Branch Office

アバー・インフォメーション株式会社

<https://jp.aver.com>

〒160-0023 日本東京都新宿区西新宿 3-2-26 立花新宿ビル 7 階

Tel: +81 (0) 3 5989 0290

テクニカル・サポート: VCIInfo.JP@aver.com

Vietnam Branch Office

Công ty TNHH AVer Information (Việt Nam)

Tầng 5, 596 Nguyễn Đình Chiểu, P.3, Quận 3, Thành phố Hồ Chí Minh 700000, Việt Nam

Tel: +84 (0)28 22 539 211

Contents

Package Contents	1
Product Introduction	2
Overview	2
Camera LED Indicator	2
Speakerphone LED Indicator	3
Expansion Speakerphone/Microphone Connection	4
Phone In Connection	5
Pan and Tilt Angle	5
Audio Signal Receive Range	6
Remote Control	7
Installation	10
Device Connection	10
RS232 Connection	12
Wall Mount Installation	18
Operating the Camera	21
Make a Video Call	21
Make a Connection through the Browser	21
Web Settings	24
First Time Login	24
Live Screen Operation	25



Set Up the Preset.....	26
Camera Settings	28
Tracking Mode.....	29
Framing Speed.....	30
Framing Size	31
Smart Frame Preset Point	31
Auto Focus	31
Camera Focus.....	32
Home Position	32
Sleep Position.....	32
Sleep Timer	32
On Screen Menu	32
Camera Binding.....	33
Save Preset.....	33
Image Settings	34
Image Flip.....	34
Image Mirror	34
True WDR.....	35
Frequency	35

White Balance	35
Noise Reduction	35
Brightness	35
Sharpness	36
Saturation	36
Low Light Compensation	36
Low Resolution under 720p (except 848*480).....	36
Enlarge Total Zoom Up to 24x	36
Video Frame Rate	37
RS232 Settings.....	37
Video Format Settings.....	38
H.264 Profile.....	38
IP Stream Resolution.....	38
Frame Rate.....	38
Bit Rate.....	39
RTSP.....	39
RTMP	40
Network Settings.....	41
Hostname	41

DHCP	41
Static IP	42
System Settings	43
Language	43
Firmware Update	43
Factory Default	44
Camera Reboot	44
Change Password	45
SSL Certificate.....	46
Date Format.....	46
Time Format	46
Time Correction Mode	47
Help Improving AVer Camera	48
Information.....	48
Audio Settings.....	49
Noise Suppression	49
Automatically Gain Control	49
Echo Cancellation.....	49
Keyboard Noise Suppression	50

AI-Noise Canceling.....	50
Reduce Reverberation.....	50
Phone In Jack.....	50
PTZApp 2.....	51
Install PTZApp 2.....	51
Use PTZApp 2 with USB Devices.....	52
Smart Gallery Operation.....	61
Install EZLive.....	63
Use EZLive.....	63

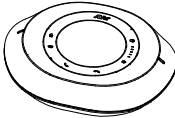
Package Contents

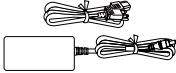
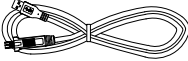
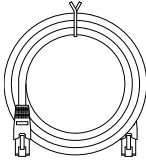
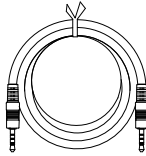
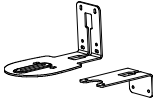
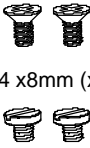
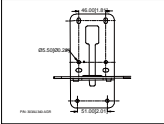
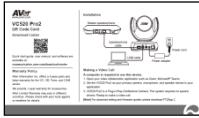
Camera Unit	Speakerphone Unit	Remote Control		Power Adapter & Power Cord*
				
USB 2.0 Type-B to Type-A Cable (5m)	Speakerphone Cable (10m)	3.5 mm Audio Cable (0.9m)	L-Mount Brackets	Screws for Mount
				 <p>M4 x8mm (x2)</p> <p>1/4"-20 L=7.5mm (x2)</p>
Drilling Paper	QR Code Card			
				

*The power cord will vary depending on the standard power outlet of the country where it is sold.

Product Introduction

Overview

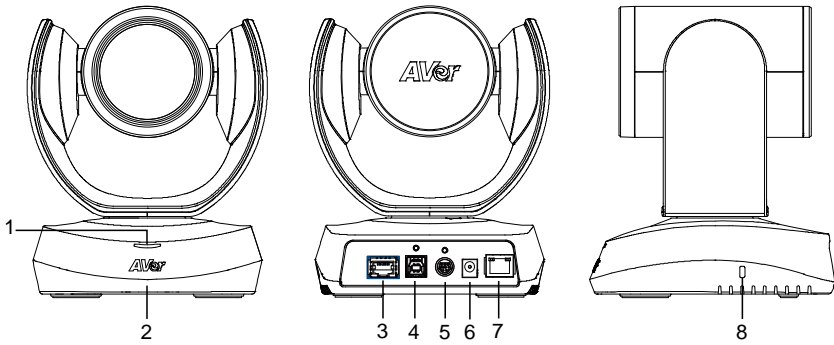

- | | | | |
|---|--------------------------------|---|-------------------|
| 1 | Status LED | 5 | RS232 In/Out Port |
| 2 | IR Sensor | 6 | DC 12V Power Jack |
| 3 | Speakerphone Port (Blue cable) | 7 | Ethernet Port |
| 4 | USB3.1 Type B Port | 8 | Kensington Lock |

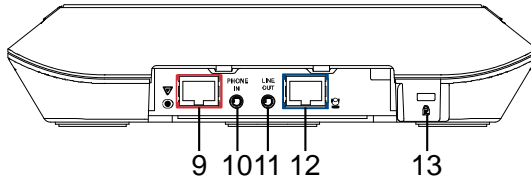

- | | | | |
|---|---|----|--------------------------|
| 9 | Speakerphone Port
(Red Cable, for extended
speakerphone and
microphone connection) | 10 | Phone In Port |
| | | 11 | Line Out Port |
| | | 12 | Camera Port (Blue Cable) |
| | | 13 | Kensington Lock |

Camera LED Indicator

Power on: Blink blue once





Start-up: Solid red

Video mute: Solid orange

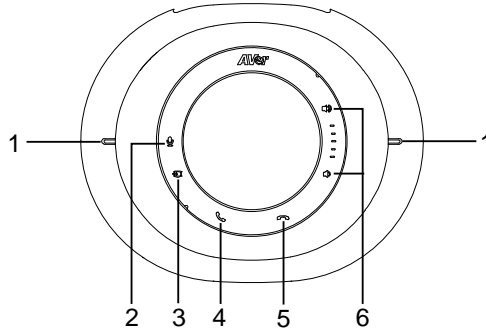
Video on: Solid blue

Speakerphone LED Indicator

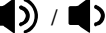

No.	LED Indicator	Status
1. LED Status Indicator	Solid red, then blink white once	Start-up
	Solid blue	Power on
	Solid orange	Idle
	Solid red	Mic mute (in meeting)
	Solid blue	Mic unmute (in meeting)
2. Mute/Unmute 	Solid red	Touch to mute the microphone.
	Solid blue	Touch to unmute the microphone.
3. Phone input 	Solid blue	Connects with external device
	Solid white	Temporarily disconnects the connection with the device
	Off	No connection with external devices
4. Make/Answer call 	Solid green	Touch to answer the incoming call.
5. Hang up call 	Solid red	Touch to hang up the call.
6. Volume up/down 	Solid white	Adjust the volume up and down. When adjusting the volume up and down, the volume LED indicator will light up in blue.
	Solid red	Touch the volume down for 1 second to mute the speaker out, the volume down button will light up in red.

Expansion Speakerphone/Microphone Connection

There are 2 types of expansion solutions that can be extended from the VC520 Pro2 speakerphone. Please purchase the expansion speakerphone and/or microphone directly from AVer or an AVer reseller.

Expansion Speakerphone Requirements:

- **VC520 Pro2 Firmware version:** 7200.00 or later
- **FONE540 Firmware version:** 7000.44 or later

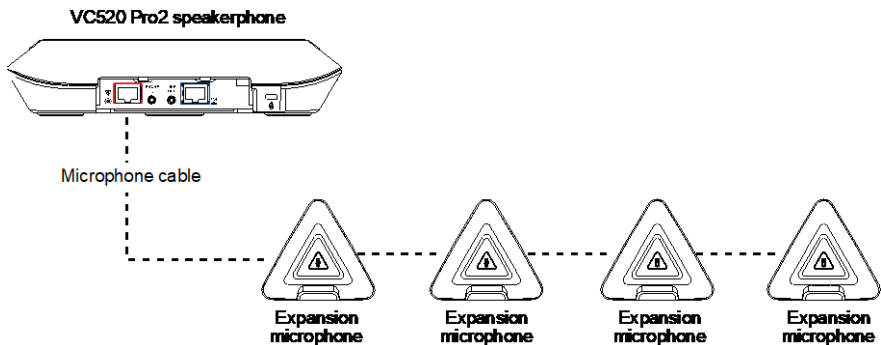
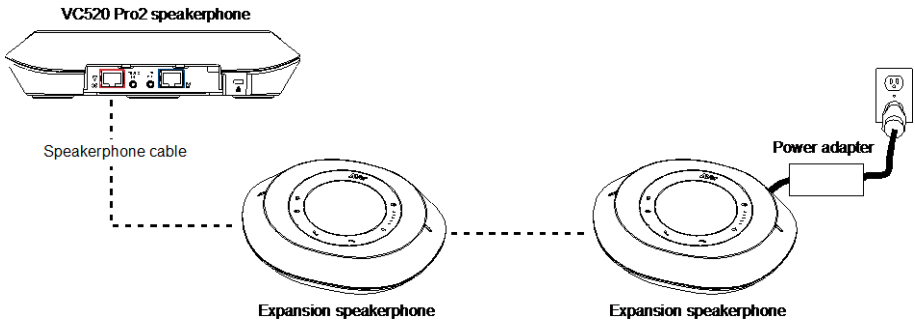

[Note]

- The VC520 Pro2 can support up to two expansion speakerphones, however, the daisy-chain expansion cable cannot exceed over 40m in total.
- Please connect the power supply for the expansion speakerphone when daisy-chaining over 20m.
- Please connect the power supply when upgrading the firmware for the expansion speakerphone.
- The expansion speakerphone cannot be used as the main speakerphone; it can only be used with the VC520 Pro2.
- The speakerphone/microphone cables will be included in the package contents when the user purchases the expansion speakerphone/microphone.



[Note] The VC520 Pro2 can support up to four expansion microphones, however, the daisy-chain expansion cable cannot exceed over 40m in total.

Phone In Connection

Users can connect a mobile phone to the Phone in port on the speakerphone as a hands-free speaker. When the device connects with the speakerphone, the  icon will light up in blue. Touching the  icon will temporarily disconnect the connection of the device with the speakerphone; touching the  icon again will resume the connection.

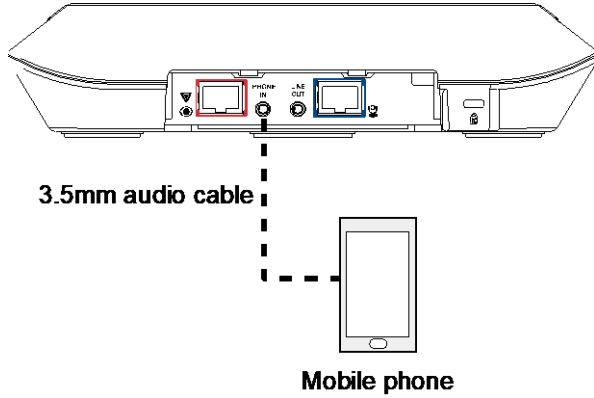

Pan and Tilt Angle

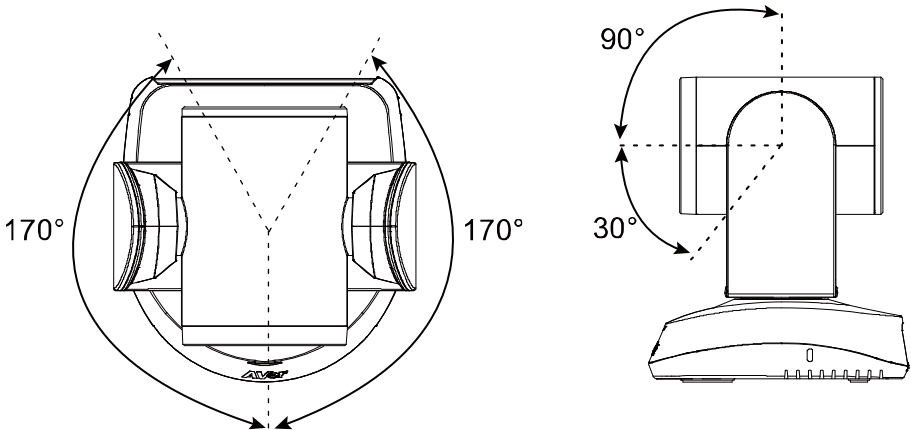

Audio Signal Receive Range

The best distance for the speakerphone to receive audio signal is within 7.5ft (2.3m) in radius. When connecting two or more speakerphones, the distance between the speakerphones must be 9ft (2.7m).

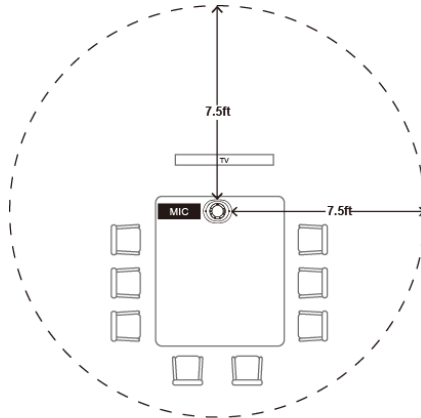

One speakerphone

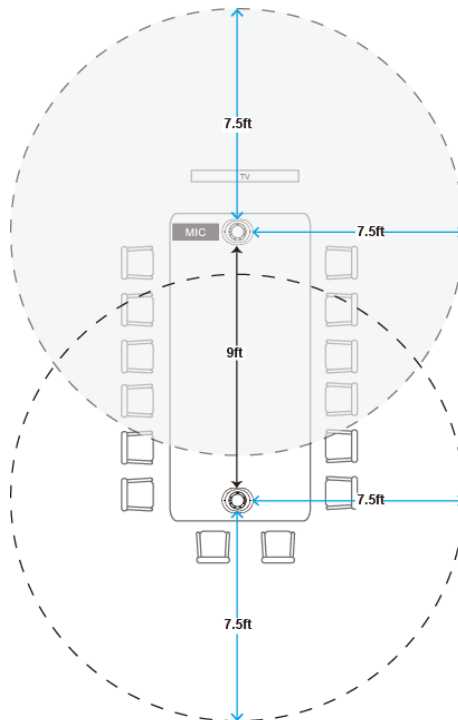

Two speakerphones

Remote Control

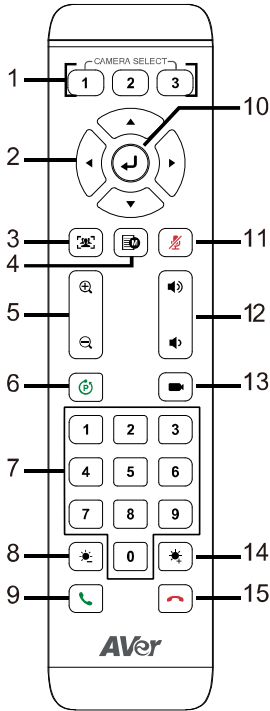

Name	Function
<p>1. Camera Select</p>	<p>One remote can control up to 3 AVer VC/CAM/VB series cameras. You can use AVer PTZApp 2 to set numbers associated with each camera, and then select which camera you would like to control using the remote.</p> <p>[Note] If you only have one camera and do not need to adjust any setting, the default is camera 1. If you press camera 2 or 3 on the remote control, you will find your remote can't control your camera. In this case, please press camera 1 on your remote again.</p>
<p>2. Camera Directional Control</p>	<p>Use the directional buttons on the remote to control the direction of the camera. Press the directional button to move the camera or press and hold to continuously pan or tilt.</p>
<p>3. SmartFrame</p>	<p>One-click automatic FOV adjustment to fit all participants.</p> <p>Press for 1 second to switch the SmartFrame function among Manual Framing/Auto Framing/Preset Framing modes. A message (as figures shown) will display on the screen to indicate the mode.</p> <div style="display: flex; justify-content: space-around; margin: 10px 0;"> <div style="background-color: black; color: white; padding: 2px 5px; font-size: 8px;">Manual Framing</div> <div style="background-color: black; color: white; padding: 2px 5px; font-size: 8px;">Auto Framing</div> <div style="background-color: black; color: white; padding: 2px 5px; font-size: 8px;">Preset Framing</div> </div> <p>[Notes]</p> <ul style="list-style-type: none"> ■ SmartFrame deploys face and body detection technology. People wearing masks and side facial profiles can still be detected. The maximum detection distance is 7~10 meters. ■ Camera will track people while moving. It will start to focus and zoom in once people stop moving for 1~5 seconds, depending on the framing speed you

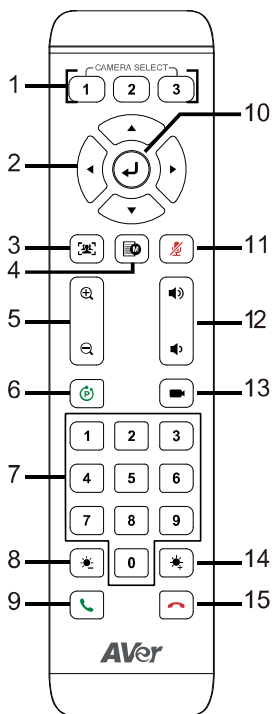

4. OSD Menu To call out OSD menu. Not supported for VC520 Pro2.

5. Zoom In/Zoom Out Increase/Decrease the camera zoom.

6. Preset The Preset button on the remote serves 2 functions.

To Save a Preset – Move camera to desired position. Press and hold the preset button until you receive the save message on the screen. Select preset position button 0-9 to store the current camera position. Repeat steps if needed.

To Load a Preset - Press the preset button and preset position button 0-9 to load a saved camera position. Repeat steps if needed.

7. Preset Position/Number Buttons Preset position buttons are used in conjunction with the Preset button to save positions. There are a total of 10 presets. Press the preset button first and then press 0~9 for the camera to move to the saved position.

[Notes]

- Press and hold the number button “1” for 1 second to turn on or off the WDR function.

- Press and hold the number button “5” for 1 second to turn on or off the SmartFrame function.

- Press and hold the number button

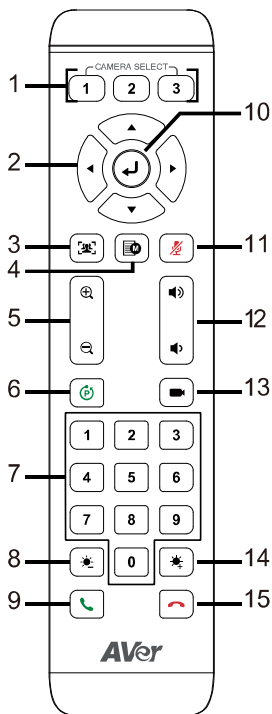

“ 8 ” for 1 second to enable or disable RTMP streaming function.

- Press and hold the number button “ 9 ” for 1 second to force camera to enter sleep mode. This will end any video streaming. To wake up the camera, press the button or any directional button for 1 second. This mode is not functional while USB streaming is on.

8. Brightness -	Decrease the brightness.
9. Call/answer	Answer a call or start a call.
10. Enter	To confirm selection. Not supported for VC520 Pro2.
11. Mute/Unmute Speakerphone	Mute/Unmute the speakerphone.
12. Volume Up/Down	Adjust volume up or down.
13. Preset Hot Key	Press to move the camera to the preset position the user has set.
14. Brightness +	Increase the brightness.
15. Hang Up	End the call.

Installation

Device Connection

1. Connect the camera to power outlet.

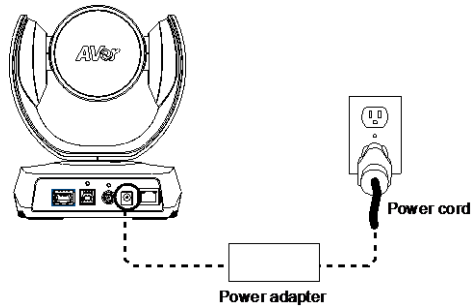

2. Connect the camera to the speakerphone using the included compatible cable.

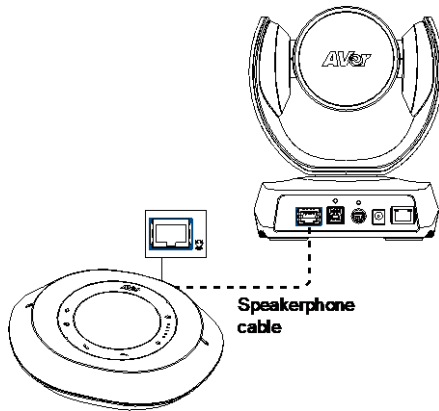

[Notes]

- The speakerphone port of the camera and the camera port of the speakerphone are both marked in blue.
- When connecting to the speakerphone, please remove the back port cover of the speakerphone for successful cable connection. To remove the back port cover, simply pull off from the speakerphone unit.

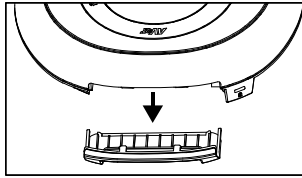

3. Connect other necessary cables.

[Notes]

- Secure the USB and RS232 cables with attached screws. RS232 cable is an optional accessory; please purchase from AVer.
- Make sure the cable is well connected to the connector on the camera before securing the cable.

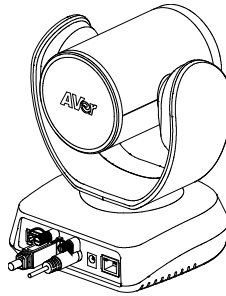

4. Connect the camera to the computer/laptop using the included compatible cable..

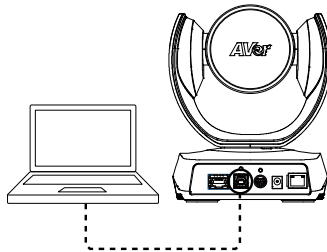

[Notes..]

- Use the USB 2.0 cable included in the package.
- VC520 Pro2 has the USB 3.1 port which is USB 2.0 compatible.

Maximum resolution/fps for USB 2.0 and USB 3.1 ports are shown below.

	M-JPEG/fps	NV12/fps	YUV/fps
USB 2.0	1080@60 fps	720p@10 fps	720p@10 fps
		480p@30 fps	480p@30 fps
USB 3.1	1080p@60 fps	1080p@30 fps	1080p@30 fps

RS232 Connection

■ Camera RS232 Port Pin Definition

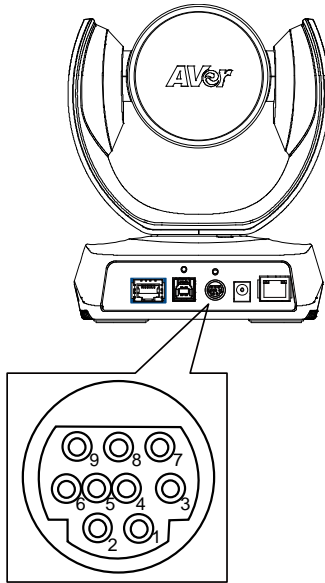

Function	Mini DIN9 PIN #	I/O Type	Signal	Description
VISCA IN	1	Output	DTR	Data Terminal Ready
	2	Input	DSR	Data Set Ready
	3	Output	TXD	Transmit Data
	6	Input	RXD	Receiver Data
VISCA OUT	7	Output	DTR	Data Terminal Ready
	4	Input	DSR	Data Set Ready
	8	Output	TXD	Transmit Data
	9	Input	RXD	Receiver Data
	5	---	---	Not connect

■ Computer/Keyboard Controller and Camera Connection

Direct Connection

If users do not use AVer RS232 adapter cable, please refer to the pin connection shown below.

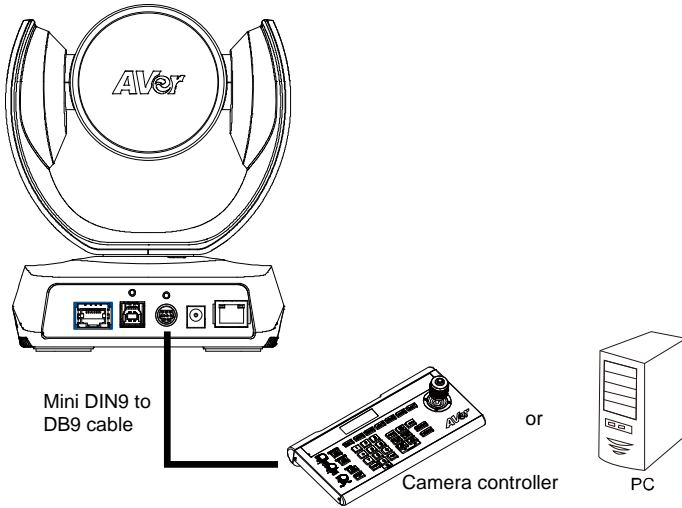

Camera (Mini DIN9)	Camera controller or PC (DB9)
1. DTR (IN)	1. DCD
2. DSR (IN)	2. RXD
3. TXD (IN)	3. TXD
6. RXD (IN)	4. DTR
7. DTR (OUT)	5. GND
4. DSR (OUT)	6. DSR
8. TXD (OUT)	7. RTS
9. RXD (OUT)	8. CTX
	9. RI

Red arrows indicate the following connections: Camera 6. RXD (IN) to PC 4. DTR; Camera 4. DSR (OUT) to PC 2. RXD; Camera 8. TXD (OUT) to PC 7. RTS; Camera 9. RXD (OUT) to PC 8. CTX.

Use the RS232 mini DIN9 to mini DIN8 cable (Sold separately. Please purchase from AVer.).

Users can purchase AVer RS232 min DIN9 to mini DIN8 adapter cable* to connect with Computer or keyboard/controller.

*RS232 mini DIN9 to mini DIN8 cable (PN: 064AOTHERCDC)

**Mini DIN8 to D-Sub9 (DB9) cable (PN: 064AOTHERBPK) is an optional item.

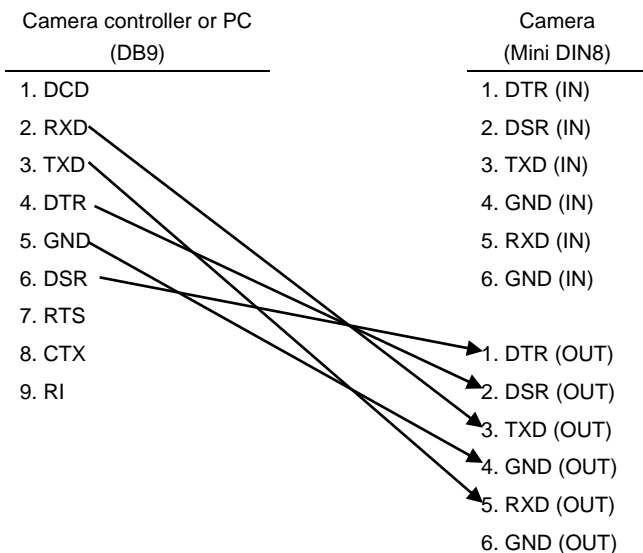
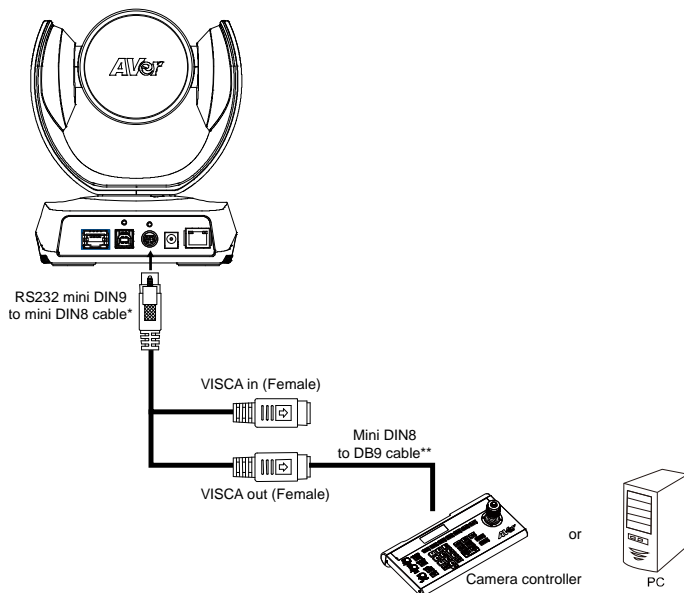

*RS232 mini DIN9 to mini DIN8 Cable Pin Definition

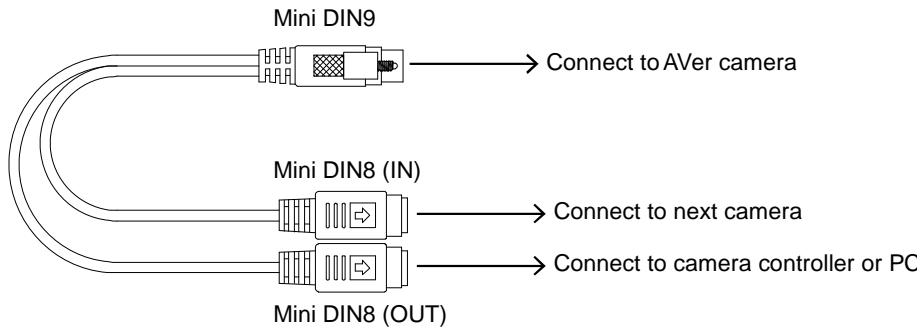

Mini DIN8 Pin Definition

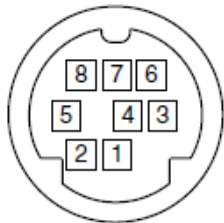

No.	Pin
1	DTR
2	DSR
3	TXD
4	GND
5	RXD
6	GND
7	NC
8	NC

■ Camera Cascade Connection

Direct Connection

If users don't buy AVer RS232 adaptor cable, please refer to the pin connection shown below for cascading cameras.

Total can connect up to 7 cameras.

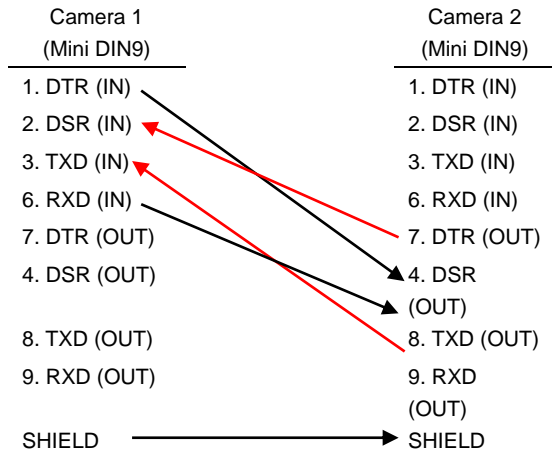
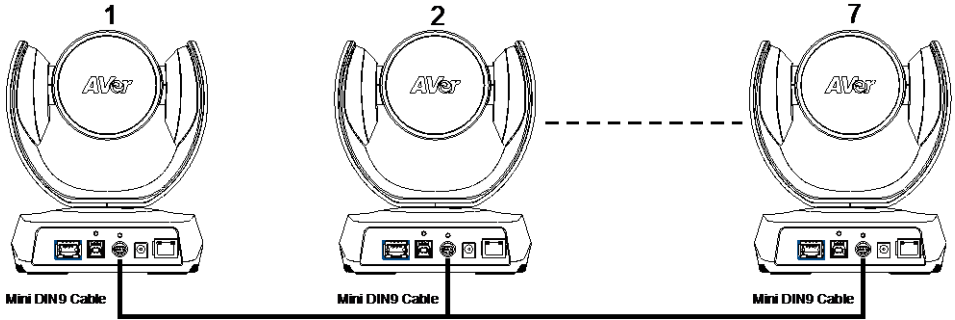

Use the RS232 mini DIN9 to mini DIN8 cable

Total can connect up to 7 cameras.

To facilitate the camera cascade, users can purchase AVer RS232 adapter cable.

Connect camera with AVer mini DIN9 to mini DIN8 adapter cable. Connect the mini DIN8 female side to male mini DIN8 Visca cable (Users have to buy it in the market) and then connect AVer mini DIN9 to mini DIN8 adapter cable again to connect to next camera.

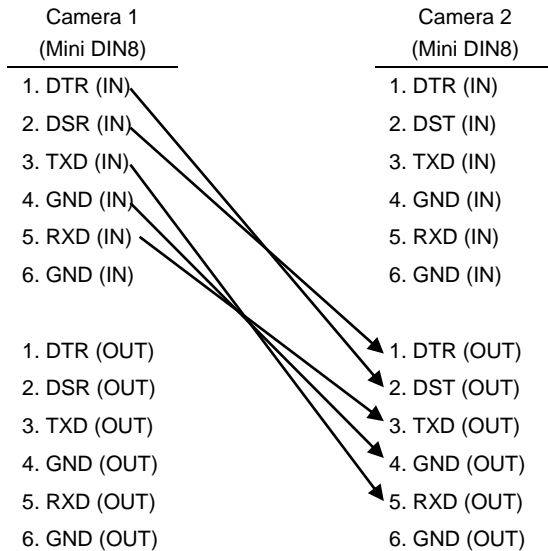
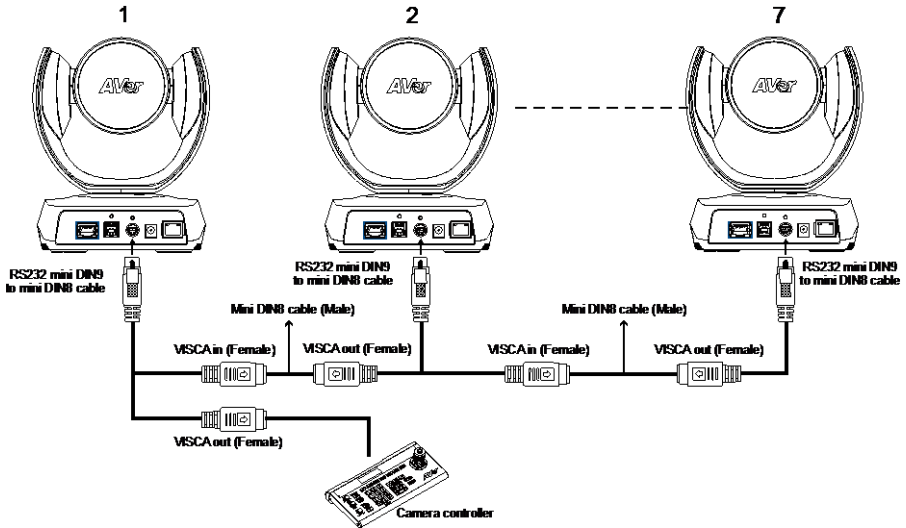

Wall Mount Installation

1. Use the drilling paper included in the package to drill the holes in the wall where the user wants to mount the camera.

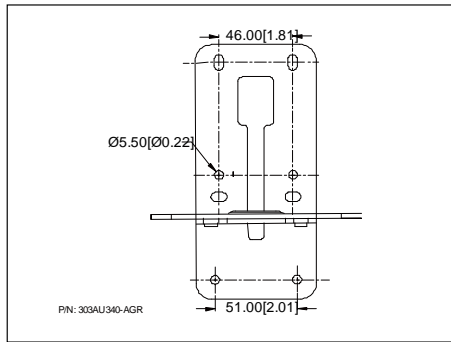

2. Use the screws (not included) to secure the L-mount bracket **A** on the wall.

Screw

For Cement wall: M4 x20mm self-tapping screws (x4) + Plastic conical anchor

For Wooden wall: M4 x20mm self-tapping screws (x4)

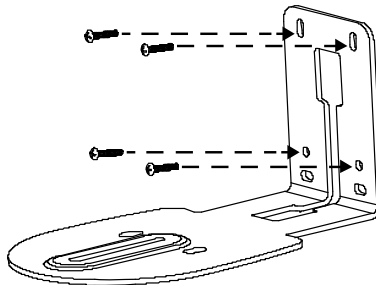

3. Then, assemble the L-mount brackets **A** + **B** with screws (included in package).

Screw:  M4 x8mm (x2)

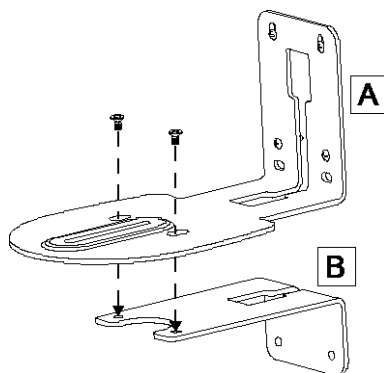

4. After assembling the L-mount brackets, use the screws (not included) to secure the L-mount bracket **B** on the wall.

Screw

For Cement wall: M4 x20mm self-tapping screws (x2) + Plastic conical anchor

For Wooden wall: M4 x20mm self-tapping screws (x2)

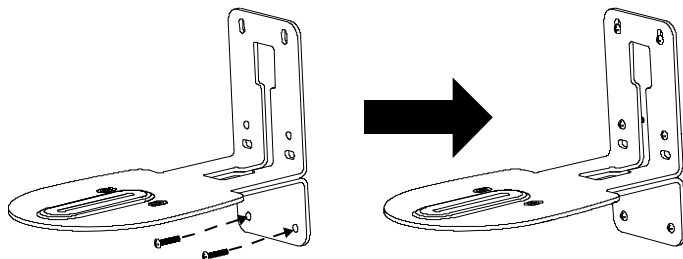

5. Pass the cables through the hole on the L-mount brackets and connect the cables to corresponding connection ports.

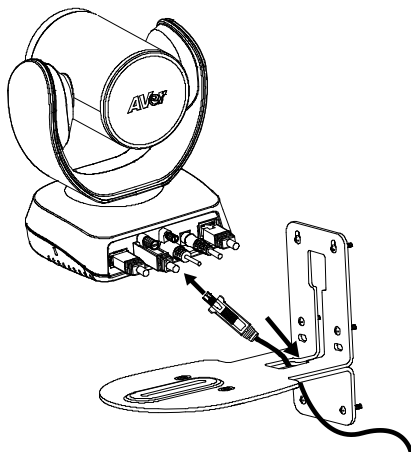

6. Use the remaining screws (included in package) to secure the camera on the L-mount brackets.

Screw:  1/4"-20 L=7.5mm (x2)

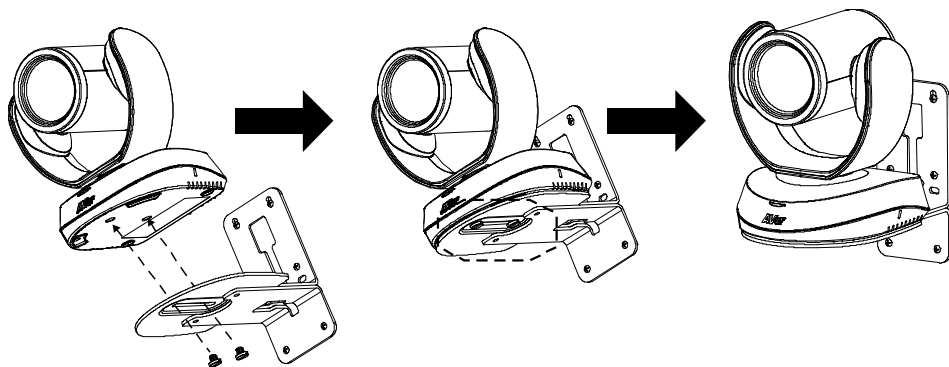

Operating the Camera

Make a Video Call

1. Make sure all devices (VC520 Pro2, speakerphone and PC/laptop) are well connected and power is on.
2. Run your video application (Zoom, Microsoft® Teams, Skype for Business, Skype, Google Meet, Intel® Unite™, RingCentral, BlueJeans, V-Cube, LiveOn, CyberLink U Meeting®, TrueConf, Adobe Connect, Cisco WebEx®, Fuze, GoToMeeting™, Microsoft® Lync™, Vidyo, vMix, WebRTC, Wirecast, XSplit, etc.) on your PC or laptop.
3. Set the VC520 Pro2 camera and speakerphone as the primary camera and speakerphone for your video application (refer to your video application user guide). You can now make your call.

[Note] The VC520 Pro2 is a plug-and-play conference camera. The system requires no special drivers, but we do recommend installing the PTZApp 2 for a better user experience. For information on how to install and use the PTZApp 2, refer to the PTZApp 2 section in this user manual.

Make a Connection through the Browser

VC520 Pro2 has an Ethernet port for IP streaming and allows administrators to remotely control and set up the camera via an internet access. Moreover, VC520 Pro2 also supports RTSP and RTMP functions. For more details, please contact our technical support.

1. Make sure the VC520 Pro2 has an internet access connection.
2. Launch PTZApp 2* () and connect VC520 Pro2 to PC with USB cable. The camera default IP address is **192.168.1.168**.



[Note] The browser supports:

- Chrome: version 76.x or above
- Firefox: version 69 or above
- Edge: 89.0.774.45 or above
- IE: Doesn't support

3. Click pencil icon (✎) to edit IP address**.

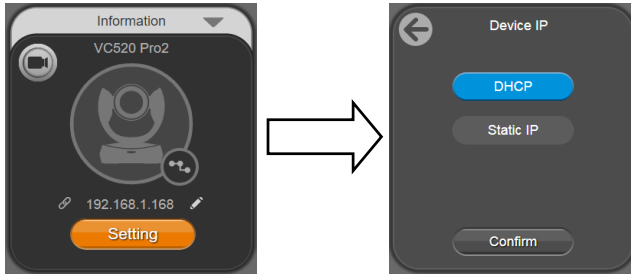

4. Click weblink icon (🔗) to launch Chrome page. Please enter the password (default password is **aver4321**). User will be asked to set a new account and password. (Please enter AVer PTZApp2 software to reset password back to default while password is forgotten.)

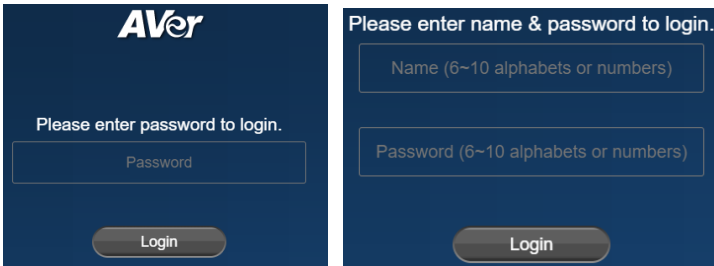

5. Input the new account, password and click **Login**, you will be prompted with a setting for sharing the non-personal data with AVer, such as the functions used and firmware versions of the AVer devices. Click to enable sharing the usage data with AVer and then click **Done**. You can optionally disable this setting afterward (**System > Help Improving AVer Camera**).

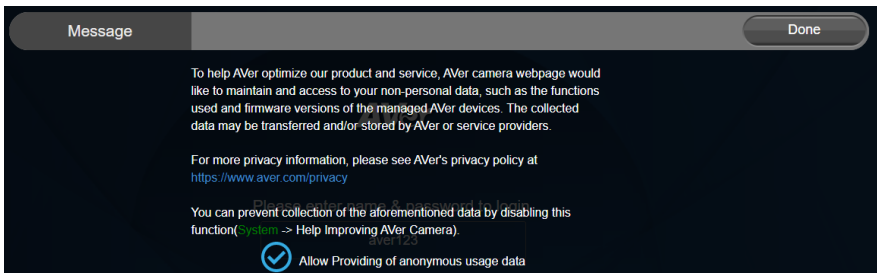

6. Now you can access web settings of the camera with only Ethernet cable connection. Unplug the USB cable.

7. The main web screen is displayed as below.

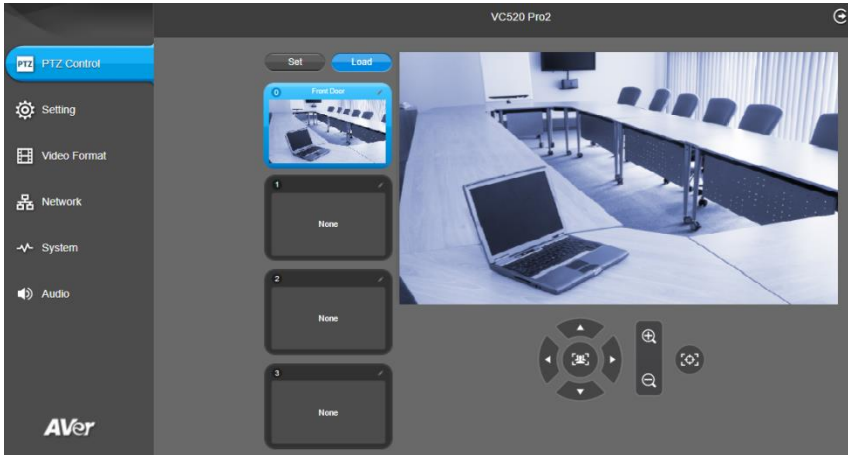

* For information on how to install and use the PTZApp 2, refer to the PTZApp 2 section in this user manual.

** To support IP address changes in groups, user can download AVer IP Finder app.

1. Download the IP Finder from <https://www.aver.com/download-center> (Headquarters & Europe) or <https://www.averusa.com/business/support/> (USA).

2. Run the IP Finder.

3. Click **“Search”**, and all available devices will be listed on the screen.

4. Select a camera from the list. The corresponding fields of IP address will display.

5. To change the IP address of camera, user can select **“DHCP”** or **“Static IP”**.

The DHCP should get the IP address from local dynamic IP sever. The static IP, user can enter the specific IP address. Click **“Apply”** to apply the setting to the camera. The password is required (default password is **aver4321**).

6. Click **“Search”** button to re-scan the camera.

7. Double-click on the IP address of camera from the list can connect to camera through the browser.

8. Enter the default password (**aver4321**) to login to Web setup screen.

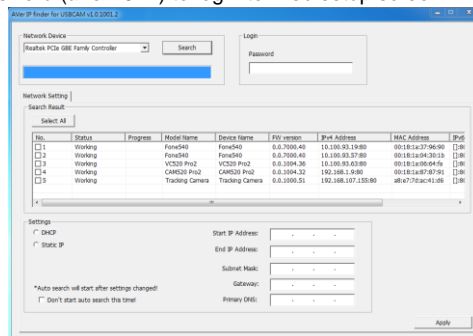

Web Settings

VC520 Pro2 supports Ethernet connection; users can enter the IP address into the web browser to connect to the camera for detail settings.

First Time Login

To find the IP address of the camera, please refer to “**Make a connection through the Browser**” section.

1. Open the browser on your laptop/PC and enter the IP address of the camera.
2. Enter the password at login screen. The default password is “**aver4321**”.
3. The main web screen is displayed.

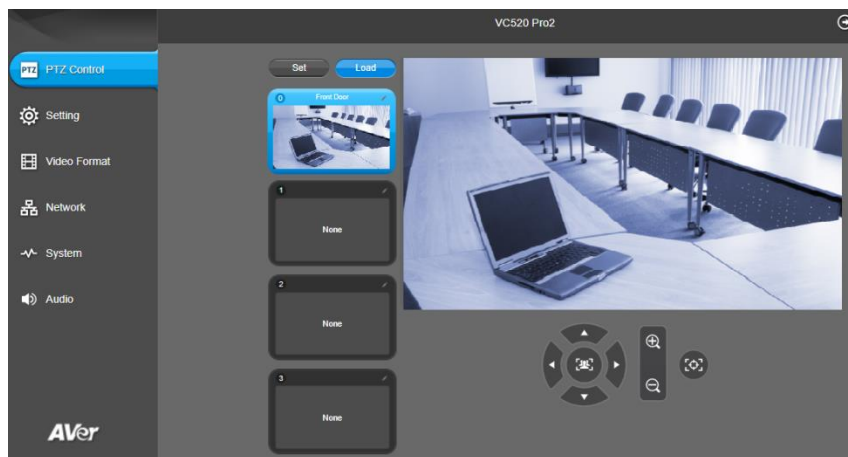

Live Screen Operation

User can control the camera direction, zoom in/out, and preset selection.

[Notes]

- The system will force the previous login to log out, when there is a second login.
If the web page is idle without any request for more than 4 hours, user will be logged out.
- The resolution of live screen is 840x480/ 10fps.

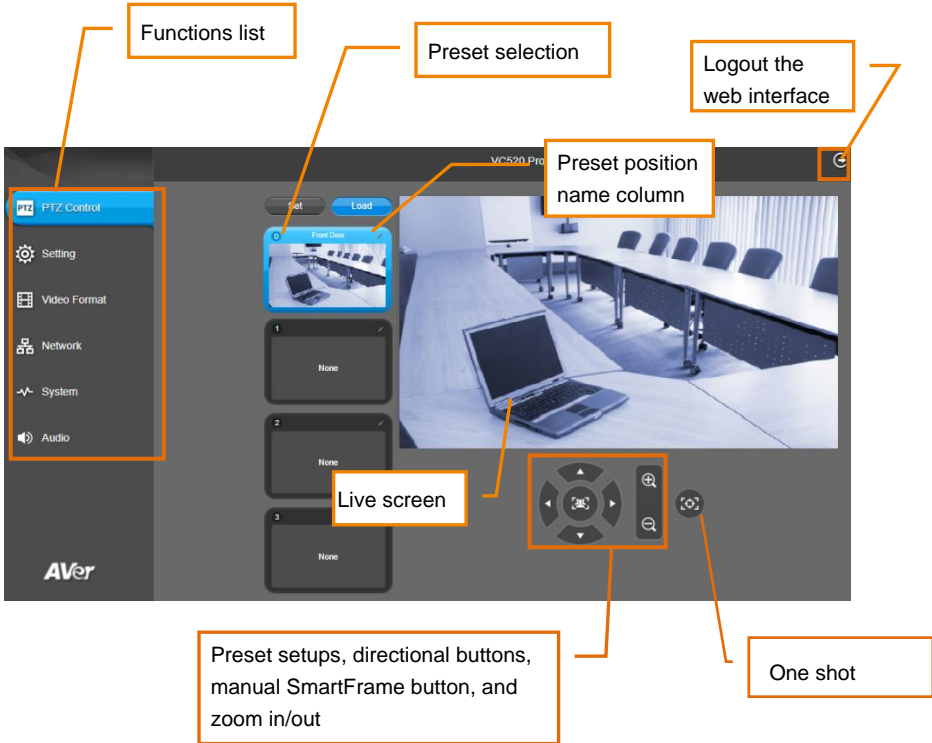

Set Up the Preset

User can set 10 preset positions.

1. In live screen, use ▲, ▼, ◀, ▶ and zoom in/out buttons to adjust the camera screen view to desired position.
2. Select “Set” button and click on the preset number to save the preset. The system will capture the preset screen view and display in preset number frame.

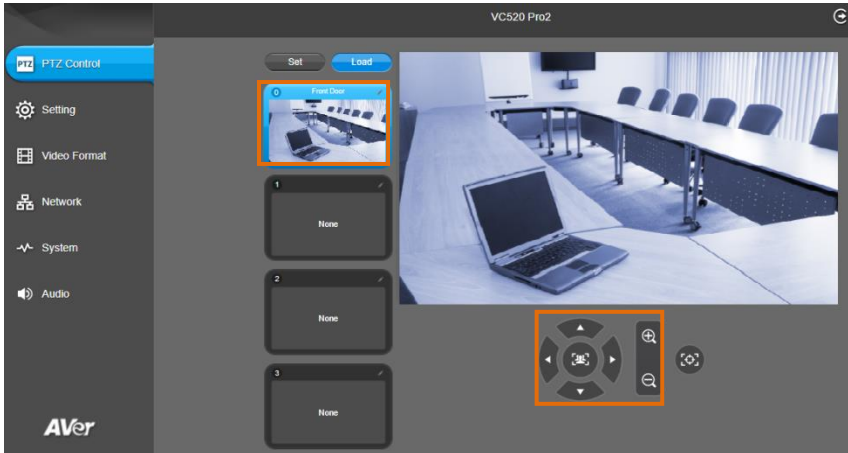

3. Select  icon to edit name of preset frame. Click other web interface to save the name edited.

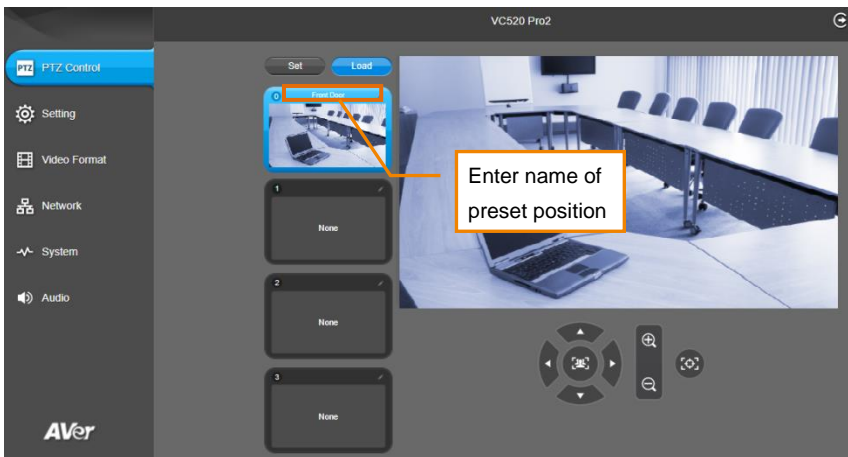

4. To set another preset, repeat the above steps.

5. After setting up the preset positions, you can start performing the function. Select the **Load** button and then click on the preset numbers, the live screen will move to the preset screen view.

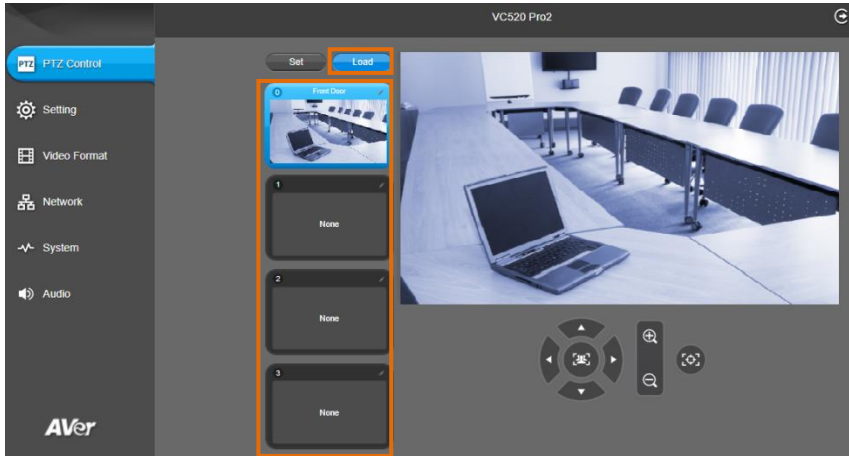

Camera Settings

The video  icon is to turn on camera live view while adjusting any settings.

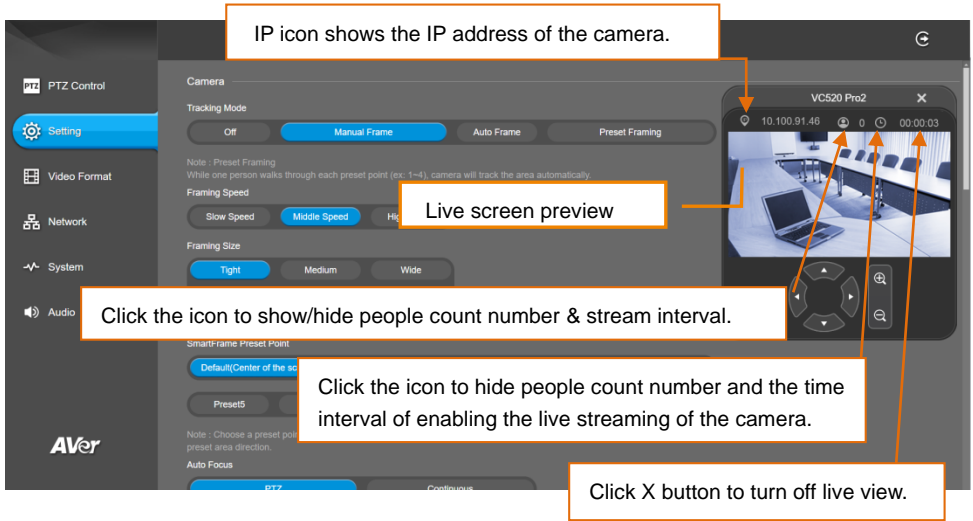

The screenshot shows the AVer PTZ Control interface. On the left is a sidebar with menu items: PTZ Control, Setting (highlighted), Video Format, Network, System, and Audio. The main area is titled 'Camera' and contains several settings sections: Tracking Mode (Off, Manual Frame, Auto Frame, Preset Framing), Framing Speed (Slow Speed, Middle Speed, High Speed), Framing Size (Tight, Medium, Wide), Smart-frame Preset Point (Default/Center of the screen, Preset5), and Auto Focus. A live view window titled 'VC520 Pro2' is open on the right, showing a meeting room. The live view window has a status bar at the top with the IP address '10.100.91.46', a camera icon, a refresh icon, a close icon, and a stream interval '00:00:03'. Below the video feed are navigation controls: a directional pad, a zoom-in icon, and a zoom-out icon. Five callout boxes with orange borders and arrows point to specific elements: 1. 'IP icon shows the IP address of the camera.' points to the IP address '10.100.91.46'. 2. 'Live screen preview' points to the video feed area. 3. 'Click the icon to show/hide people count number & stream interval.' points to the camera icon in the status bar. 4. 'Click the icon to hide people count number and the time interval of enabling the live streaming of the camera.' points to the refresh icon. 5. 'Click X button to turn off live view.' points to the close 'X' icon in the top right corner of the live view window.

IP icon shows the IP address of the camera.

Live screen preview

Click the icon to show/hide people count number & stream interval.

Click the icon to hide people count number and the time interval of enabling the live streaming of the camera.

Click X button to turn off live view.

Tracking Mode

Select **Setting > Camera > Tracking Mode > Off, Manual Frame, Auto Frame, or Preset Framing.**

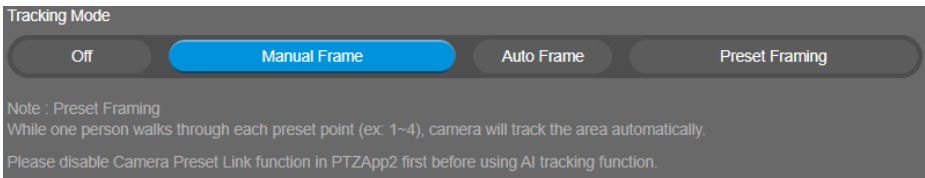

- **Off:** Tracking mode is disabled.
- **Manual Frame:** User one-click SmartFrame button and camera will adjust view angle to fit all participants in screen for once.
- **Auto Frame:** Camera automatically adjusts view angle to frame all participants on screen every time when it detects participants' faces or bodies. This action will be activated once people in the room sit or stand still for 1~5 seconds, depending on the framing speed you select.* Once all the participants are in frame, the camera will keep the image stable by not completing any action until subjects move in or out of the screen. When a participant touch the sides of the screen, it will trigger the camera and automatically track, detect, and frame all the participants again.

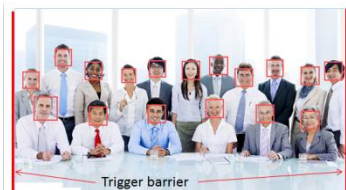

*The default framing speed is "Middle" speed. "High" speed is more suitable for one person tracking.

- **Preset Framing:** Set up preset points in advance. (Only for Preset points 1~9. Preset 0 is for home position). This is designed for requiring a specific zooming area with preferred image proportion. Camera tracks and frames all the participants in the screen if none of them touch any preset area. When any of them touch a preset area, the camera will immediately shoot the preset zones instead of focusing and zooming into presenter. To keep the screen stable, whenever there is a person in the area, the camera won't move any more until no one shows up. However, the camera can detect the direction where the last person goes. If the person goes to the next preset area with overlap section, the camera will directly move to the next preset area. Thus, to ensure smooth transition, please set up zones with overlapping presets.
If the preset zones do not overlap and when the last person leave the preset area, camera will zoom out to wide to find people and frame them again.
If more than 2 presets areas are touched by 2 persons, camera will go to preset 1. The priority is preset 1>preset2> preset 3....>preset 9

Overlap beginning & end of each zone



[Note] VC520 Pro2 frames people in masks or any facial profile up to 7~10 meters away!

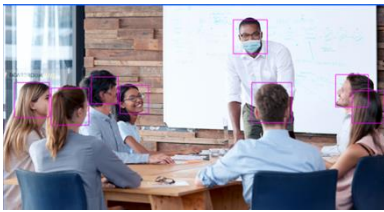

Framing Speed

Select **Setting > Camera > Framing Speed > Slow Speed, Middle Speed** (default), or **High Speed**.

When in auto framing or preset framing mode, camera will automatically frame people if they stand still without moving for 1~5 seconds.

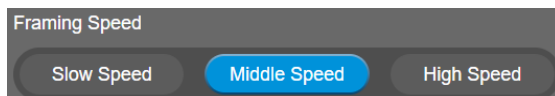

- **Slow Speed:** camera starts to frame people if they don't move for 5 seconds.
- **Middle Speed:** camera starts to frame people if they don't move for 3 seconds.
- **High Speed:** camera starts to frame people if they don't move for 1 second.

[Note] The default framing speed is "Middle" speed. "High" speed is more suitable for one person tracking.

Framing Size

Select **Setting** > **Camera** > **Framing Size** > **Tight, Medium, or Wide.**

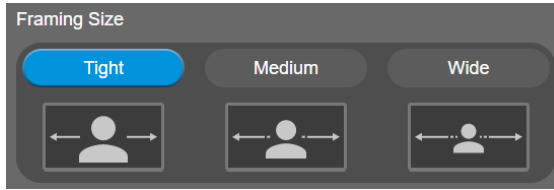

- **Tight** (default): It provides a close-up view of meeting participants.
- **Medium**: It provides a medium view of meeting participants.
- **Wide**: It provides a wide view of meeting participants.

Smart Frame Preset Point

Select **Setting** > **Camera** > **Smart Frame Preset Point** > **Default(Center of the screen)** or **Preset0** ~ **Preset9**.

The default is the central of the image screen. Choose a preset point so that camera can detect participants from the wide view of the assigned preset area direction.

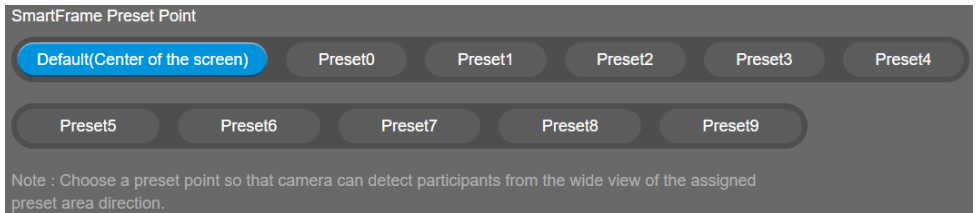

Auto Focus

Set auto focus mode.

First select **Setting** > **Camera** > **Camera Focus** > **Auto**.

Select **Setting** > **Camera** > **Auto Focus** > **PTZ** or **Continuous**.

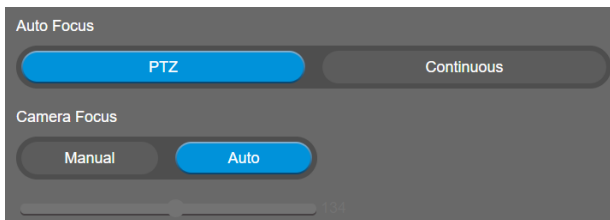

- **PTZ**: Click the button (such as pan, tilt, or zoom in/out) to adjust focus once.
- **Continuous**: The camera will adjust the focus when the objects have moved.

Camera Focus

Set auto/manual focus mode.

Select **Setting > Camera > Camera Focus > Auto or Manual.**

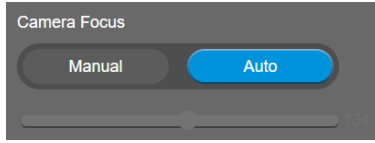

- **Auto:** Camera adjusts focus automatically.
- **Manual:** You can adjust the camera focus by moving the control bar below.

Home Position

Every time when powering on the camera, it will turn to this position.

Select **Setting > Camera > Home Position > Last Operation Position, Factory Center Position, or Preset 0.**

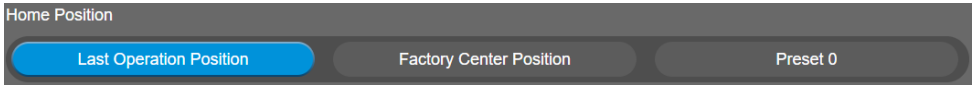

Sleep Position

When the camera idles for certain period, it will enter sleep mode and go to the sleep position. Please set up sleep timer to enable sleep mode.

Select **Setting > Camera > Sleep Position > Factory Downside Position or Preset 9.**



Sleep Timer

Set the camera idle time to enter sleep mode.

Select **Setting > Camera > Sleep Timer > Off, 10 sec, 5 min, 10 min, or 20 min.**

Please notice that whenever there is USB streaming or RTSP/RTMP streaming, the camera won't enter sleep mode.

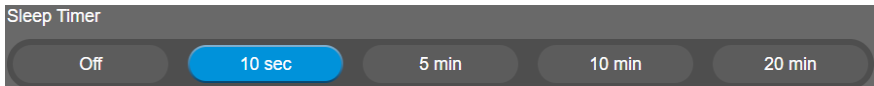

On Screen Menu

Enable/disable on screen display status information. For instance, when it is at auto frame mode, it will appear "Auto framing" on the bottom of the screen. If you don't want to see the words, please select Off.

Select **Setting > Camera > On Screen Menu > Off, On, or Load Preset Off.**



Camera Binding

With multiple cameras connection, users can set each camera to buttons 1 to 3 on the remote control. Select **Setting > Camera > Camera Binding > Off, Camera1, Camera2, or Camera3.**

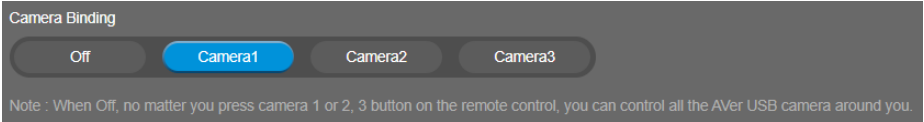

Save Preset

Enable/disable "save preset" function. When applicable, IT personnel can limit end-user access to change preset points by locking "save preset" function and switching this function off. When off, user can't save preset points via IR remote, Hot key, VISCA, and webpage. Select **Setting > Camera > Save Preset > Off or On.**

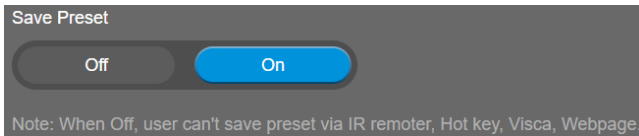

Image Settings

Image Flip

If the VC520 Pro2 is installed in the upside down position, please enable the "Flip".
Select **Setting > Image > Image Flip > Off or On.**



Image Mirror

To mirror the camera image.

Select **Setting > Image > Image Mirror > Off or On.**



True WDR

In back light environment, enabling WDR to improve the brightness of image.

Select **Setting > Image > True WDR > Off or On.**

The frame rate will be limited to 30fps while WDR is on.

If user enables this function in a normal light condition, the image will become over exposure and encounter image blur.

When WDR is enabled, camera has taken long exposure and user cannot manually adjust the brightness of image.



Frequency

Select the frequency of the camera.

Select **Setting > Image > Frequency > 50 HZ or 60 HZ.**



White Balance

Select the white balance setting for various light conditions or color temperature.

Select **Setting > Image > White Balance > Auto or Manual.**

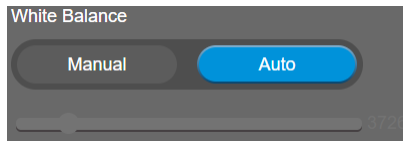

Noise Reduction

To reduce the noise from the signal.

Select **Setting > Image > Noise Reduction > Off, Low, Middle or High.**



Brightness

Adjust the value of brightness.

Select **Setting > Image > Brightness > 1 ~ 9.**



Sharpness

Adjust the value of sharpness.

Select **Setting > Image > Sharpness > Off, Low, Middle or High.**



Saturation

Adjust the value of saturation.

Select **Setting > Image > Saturation > 1 ~ 9.**

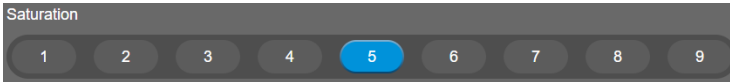

Low Light Compensation

Select **Setting > Image > Low Light Compensation > Off or On.**

Please notice that the frame rate will drop to 10~15 fps.

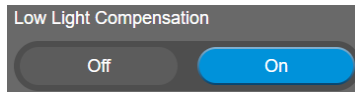

Low Resolution under 720p (except 848*480)

Select **Setting > Image > Low resolution under 720p > Disable or Enable.**

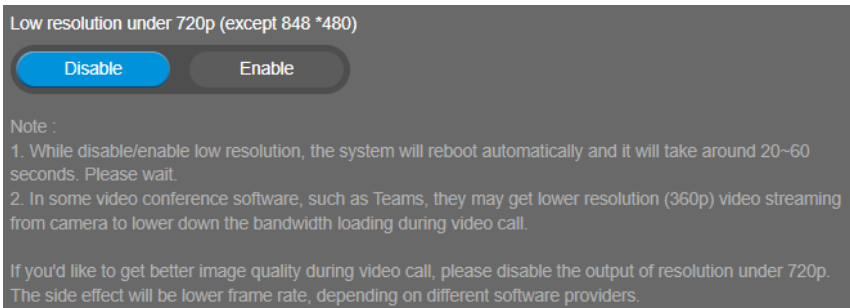

Enlarge Total Zoom Up to 24x

Select **Setting > Image > Enlarge Total Zoom Up to 24x > Disable or Enable.**

Enable/Disable enlarge zoom up to 24x.

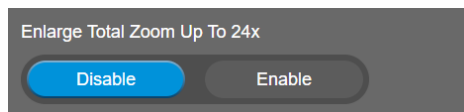

Video Frame Rate

Set up the frame rate value.

Select **Setting > Image > Video Frame Rate > 30Fps** or **60Fps**.

30fps is with much better image quality than 60fps. Unless you want to shoot fast moving objects, please use 30fps.

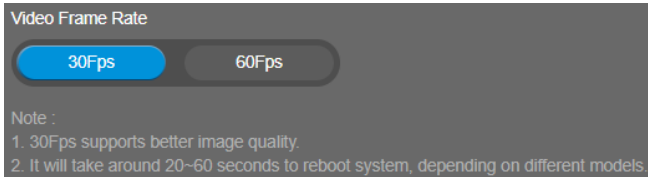

RS232 Settings

When VC520 Pro2 connects with PTZ camera controller through the RS232 port, please set up **ADDR**, **Baud Rate**, **Protocol**, and **Visca Over IP** settings.

Select **Setting > RS232**.

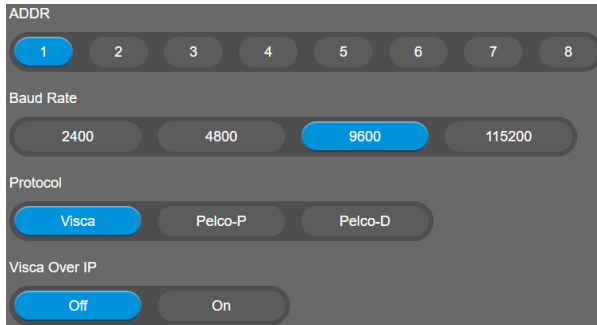

Video Format Settings

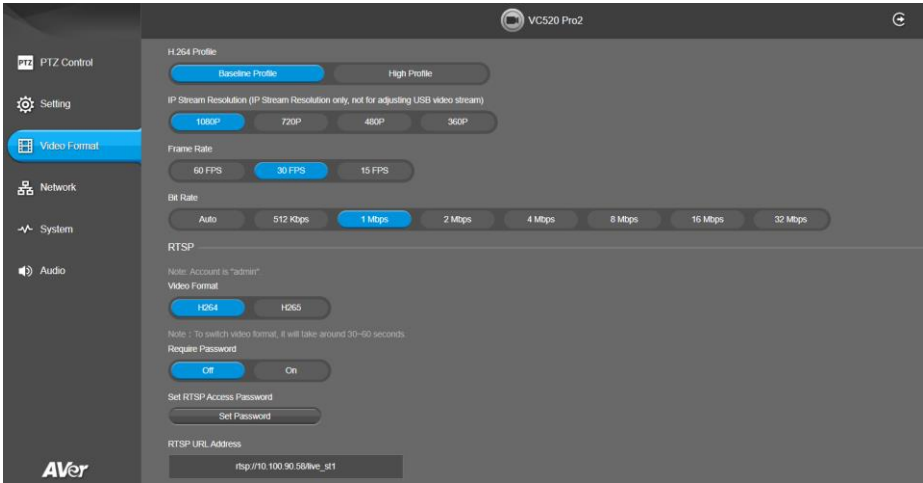

H.264 Profile

While in live broadcasting, user can choose preferable profile to get best streaming quality.

Select **Video Format > H.264 Profile > Baseline Profile** or **High Profile**.



IP Stream Resolution

Set up the resolution for IP stream. Not supported for USB video stream.

Select **Video Format > IP Stream Resolution only (not for adjusting USB video stream) > 1080P, 720P, 480P, or 360P**.

Please notice that if USB streaming (VC software side) is already in use at 1080p/30fps, the IP streaming resolution (RTSP) will be limited to 720p/30fps. It's better to disconnect USB streaming while having RTSP/ RTMP IP streaming to ensure the video transmission quality.

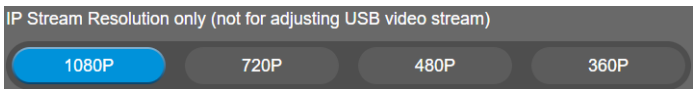

Frame Rate

Set up the frame rate value.

Select **Video Format > Frame Rate > 60 FPS, 30 FPS, or 15 FPS**.

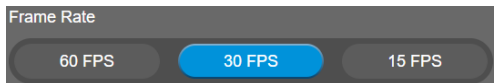

Bit Rate

Set up the bit rate value.

Select **Video Format > Bit Rate > Auto, 512 Kbps, 1 Mbps, 2 Mbps, 4 Mbps, 8 Mbps, 16 Mbps, or 32 Mbps.**

For Facebook live broadcasting, it's suggested to choose less than 4Mbps to ensure smooth streaming.



RTSP

To use RTSP player connecting to the camera, please enter the RTSP URL which displays on the web in your application such as VLC, PotPlayer or Quick Time.

Select **On/Off** to enable/disable password requirement while opening RTSP.

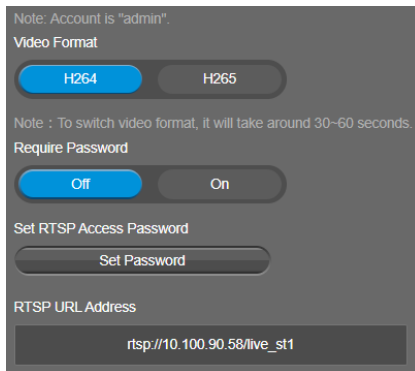

Change RTSP Password

1. Select **Video Format > RTSP > Set RTSP Access Password > Set Password.**
2. Enter the new password.
3. Select **Change** to save the new password.

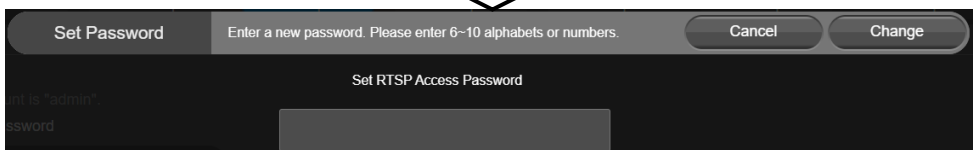
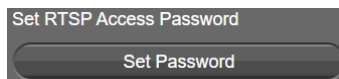

RTMP

Set up for uploading the camera's live view to the broadcasting platform (e.g. YouTube).

Select **Video Format > RTMP**.

1. Locate the RTMP server URL and stream key from the broadcasting platform and enter in **Server URL** and **Stream Key** fields.
2. Select **Start** to begin uploading the live video of the camera to the broadcasting platform.
3. Select **Stop** to stop uploading the video.

Note: Due to Facebook limitation, to ensure video quality, please set maximum Bitrate at 4Mbps.

Server URL

Stream Key

Start Using RTMP

Start

Network Settings

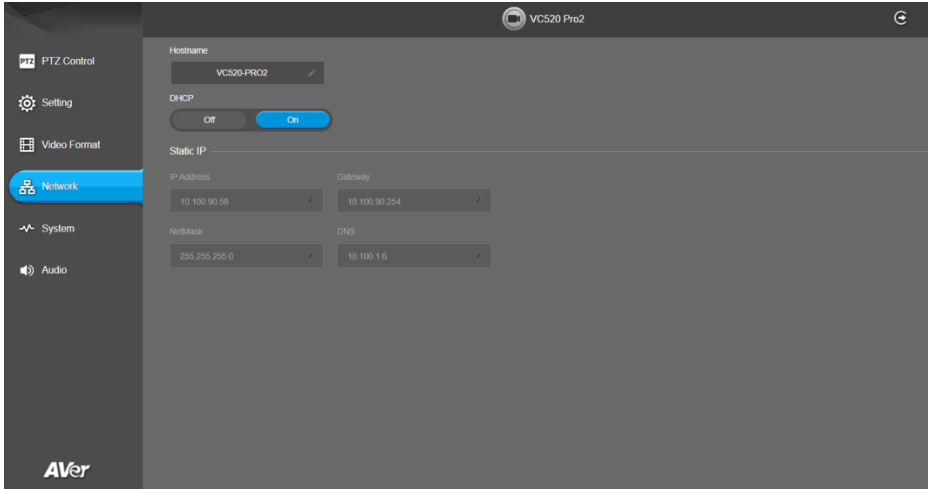

Hostname

User can set a hostname. The hostname only allows numeric and alphabetic characters.

Select **Network** > **Hostname**. Click the pencil icon to enter hostname.



DHCP

Enable/disable DHCP function.

Select **Network** > **DHCP** > **Off** or **On**.



Static IP

Assign a fixed IP address to the camera. Please turn off the DHCP function.

1. Select **Network > DHCP > Off**.
2. Click pencil icon and enter the **IP Address**, **Gateway**, **NetMask**, and **DNS** in the corresponding fields.
3. Select **Confirm** to complete the setting.

DHCP

Off On

Static IP

IP Address: 10.100.91.46

Gateway: 10.100.91.254

NetMask: 255.255.255.0

DNS: 10.100.1.6



IP Address: 10 100 91 46

Gateway: 10 100 91 254

NetMask: 255 255 255 0

DNS: 10 100 1 6

Confirm

System Settings

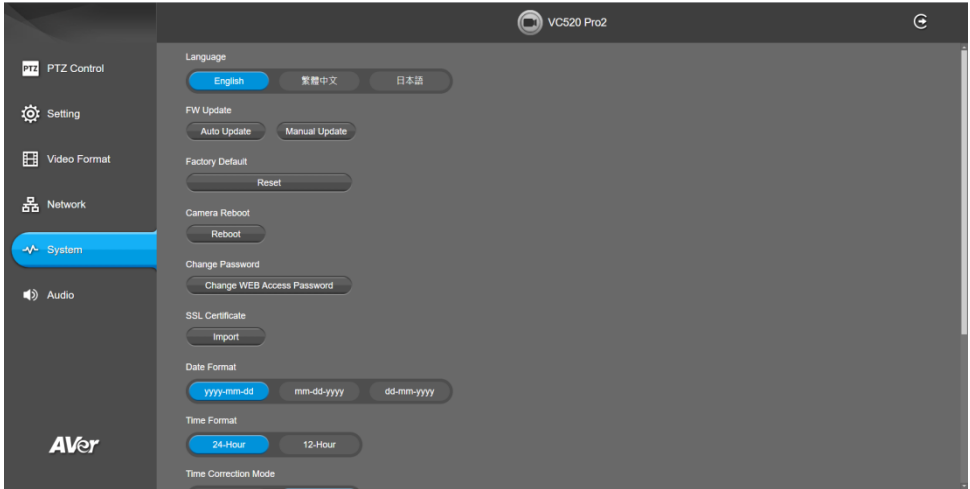

Language

Select the language of the system.

Select **System** > **Language** > **English**, **Traditional Chinese**, or **Japanese**.

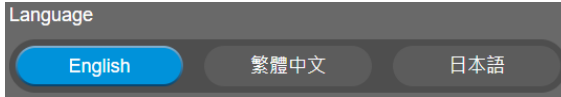

Firmware Update

Update the camera's firmware.

Select **System** > **FW Update** > **Auto Update** or **Manual Update**.



- **Auto Update:** The system will check firmware version from AVer server and request to update.
- **Manual Update:** To update the firmware from specific location.

After updating, the camera will **reboot** and the connection will be lost. Please wait for few minutes and always keep the power cable connected. If unplugging the power during this process, it will cause damage of the device.

Factory Default

Reset the camera back to factory default setting.

1. Select **System** > **Factory Default** > **Reset**.
2. User can choose to keep current IP address or back to default.
3. Select **Continue** to reset back to factory default.

[Note] When factory default is activated, the password of Webpage login will not be set to default. For security concerns, to reset password of webpage access, please download PTZApp 2 to reset it.

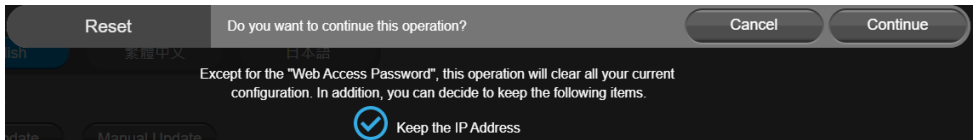
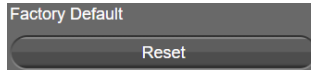

Camera Reboot

Restart the camera manually.

1. Select **System** > **Camera Reboot** > **Reboot**.
2. Select **Continue** to reboot the camera.

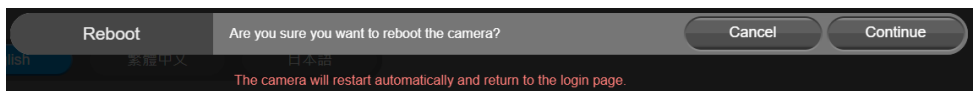
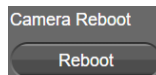

Change Password

Change the web login password. The default password is **aver4321**.

1. Select **System > Change Password > Change WEB Access Password**.
2. Enter the old account and password. Select **Continue**.
3. Enter the new account and password. Select **Continue** to save the new setting.
4. If users forget the password and want to revert back to the default password, please use PTZApp 2 to reset it.

A screenshot of the "Change Password" screen. The title bar says "Change Password" and the subtitle is "Please enter old name & password for change." There are "Cancel" and "Continue" buttons on the right. The screen has a dark background with white text. On the left, there are language options: "English", "繁體中文", and "日本語". Below the subtitle, there are two input fields: "Name" and "Password". On the left side, there are buttons for "Manual Update" and "Default".A screenshot of the "Change Password" screen. The title bar says "Change Password" and the subtitle is "Please change new name & password for login." There are "Cancel" and "Continue" buttons on the right. The screen has a dark background with white text. On the left, there are language options: "English", "繁體中文", and "日本語". Below the subtitle, there are two input fields: "Name (6-10 alphabets or numbers)" and "Password (6-10 alphabets or numbers)". On the left side, there are buttons for "Manual Update" and "Default".

SSL Certificate

Import the SSL certificate from specific location.

1. Select **System > SSL Certificate > Import**.
2. Select the type by clicking "+".
3. Direct the file location.
4. Select **Import**.

[Note] Users can use PTZApp 2 to disable SSL function.

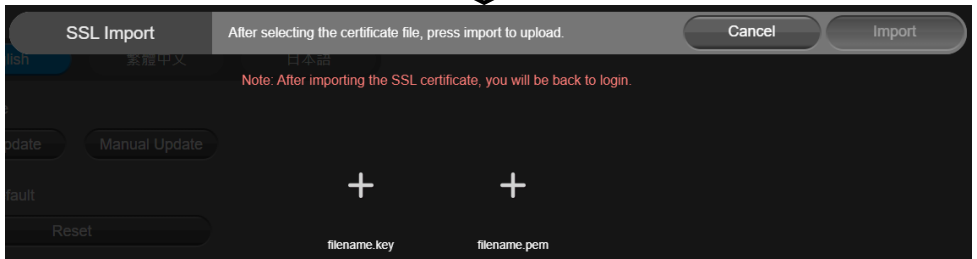
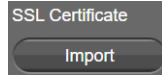

Date Format

Select the date format.

Select **System > Date Format > yyyy-mm-dd, mm-dd-yyyy, or dd-mm-yyyy**.

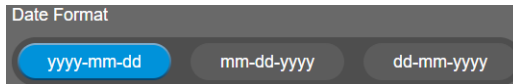

Time Format

Set up the time format.

Select **System > Time Format > 24-Hour or 12-Hour**.



Time Correction Mode

Adjust time automatically or manually.

Select **System** > **Time Correction Mode** > **Auto** or **Manual**.

- **Auto:** The system time will be set by NTP server on the network. Click the pencil icon of NTP Server and enter the URL of NTP server. Select the **Time Zone**. Select **NTP Update** to save setting. Select **Confirm** to start auto time adjustment.

[Note] Our default NTP server is located in the USA. If this does not work in your country, please manually key in the desired NTP server.

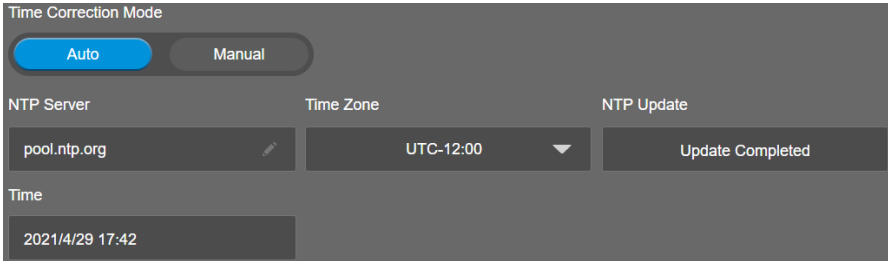

The screenshot shows the 'Time Correction Mode' interface. At the top, there are two buttons: 'Auto' (highlighted in blue) and 'Manual'. Below this, there are three main sections: 'NTP Server' with the value 'pool.ntp.org' and a pencil icon; 'Time Zone' with a dropdown menu showing 'UTC-12:00'; and 'NTP Update' with a button labeled 'Update Completed'. At the bottom, there is a 'Time' field showing '2021/4/29 17:42'.

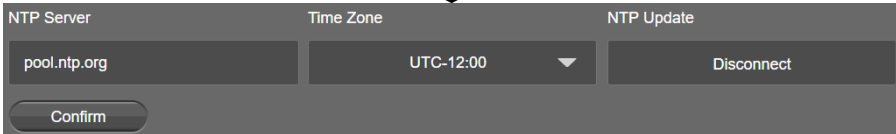

This screenshot is similar to the previous one, but the 'NTP Update' button is now labeled 'Disconnect'. The 'Confirm' button at the bottom is highlighted in blue, indicating it is the next step to be clicked.

- **Manual:** User can set up time manually. Click the pencil icon and enter the **Year, Month, Day, Hour, and Minute**. Select **Confirm** to save the settings.

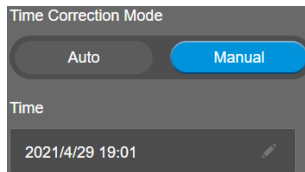

The screenshot shows the 'Time Correction Mode' interface. At the top, there are two buttons: 'Auto' and 'Manual' (highlighted in blue). Below this, there is a 'Time' field showing '2021/4/29 19:01' with a pencil icon.

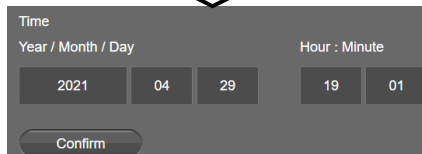

This screenshot shows the manual time input interface. It has a 'Time' section with two sub-sections: 'Year / Month / Day' and 'Hour : Minute'. Each sub-section has five input fields. The 'Year / Month / Day' fields contain '2021', '04', and '29'. The 'Hour : Minute' fields contain '19' and '01'. A 'Confirm' button is at the bottom.

Help Improving AVer Camera

By enabling this function, your non-personal usage data helps AVer to continuously improve our products and services.

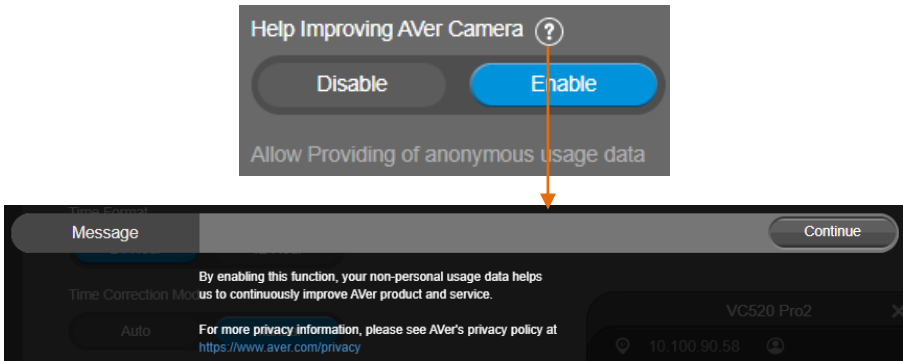

Information

Display the information of **Model Name**, **Firmware Version**, **Serial Number**, **IP Address**, and **MAC Address**.

Select **System > Information**.

Model Name	Firmware Version	Serial Number
VC520 Pro2	0.0.7200.32	1234567890123
IP Address	MAC Address	
10.100.91.93	7e:67:58:f7:1a:6d	

Audio Settings

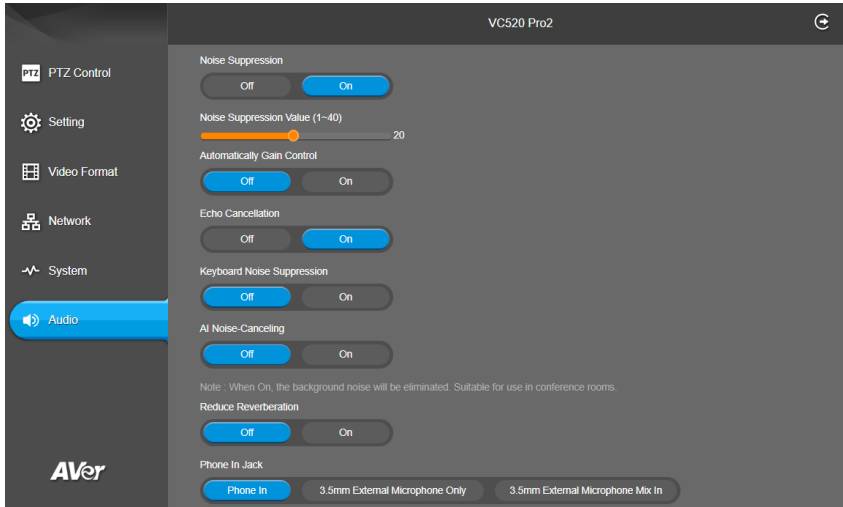

Noise Suppression

It is to reduce ambient noise.

Select **Audio > Noise Suppression > Off** or **On**.

When enabling the noise suppression function, please set value of noise suppression (1-40).

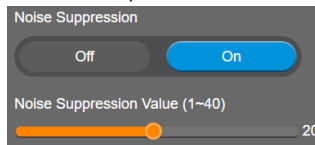

Automatically Gain Control

Enable/disable the auto gain control. It is to control ambient sound level and maintain a suitable output, despite variation of the one at the input.

Select **Audio > Automatic Gain Control > Off** or **On**.

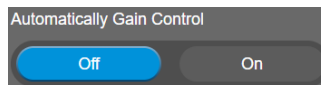

Echo Cancellation

Enable/disable echo situation.

Select **Audio > Echo Cancellation > Off** or **On**.

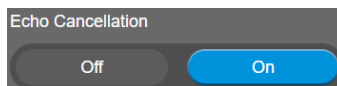

Keyboard Noise Suppression

Enable/disable keyboard noise reduction.

Select **Audio > Keyboard Noise Suppression > Off** or **On**.

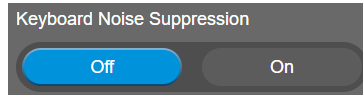

AI-Noise Canceling

Select **Audio > AI Noise-Canceling > Off** or **On**.

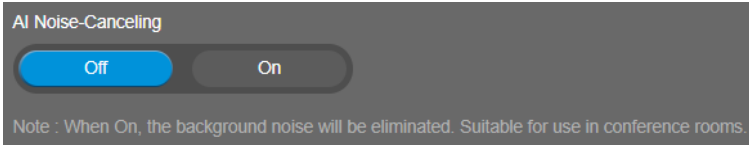

Reduce Reverberation

Select **Audio > Reduce Reverberation > Off** or **On**.

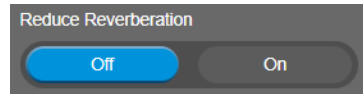

Phone In Jack

Set Phone in input source.

Select **Audio > Phone In Jack > Phone In, 3.5mm External Microphone Only, or 3.5mm External Microphone Mix In**.

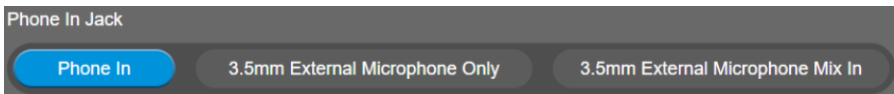

- **Phone In:** When the mobile phone is connecting to Phone in port, please select “Phone In” option.
- **3.5mm External Microphone Only:** The speakerphone will transfer the sound that it receives from the external microphone (connected on phone in port) to far site.
- **3.5mm External Microphone Mix In:** The speakerphone will transfer the sound that it receives from the external microphone (connected on phone in port) and speakerphone to far site.

PTZApp 2

In PTZApp 2, user can change the IP address setting of VC520 Pro2, configure the parameters of the camera, set up AI tracking functions and some advanced image and audio settings, pan, tilt, and zoom the camera.

Install PTZApp 2

Please go to <https://www.aver.com/download-center> (Headquarters & Europe) or <https://www.averusa.com/business/support/> (USA) to download the PTZApp 2. After downloading, double-click on the file and follow the on-screen instructions to complete the installation. After installing the PTZApp 2, double-click on the PTZApp 2 icon to run the application.

[Notes]

While installing PTZApp 2, if you refuse to install Smart Gallery plug-in in your PC (illustrated as below), you will not be able to use the function. To enable the function, please reinstall PTZApp 2 for the necessary plug-in.

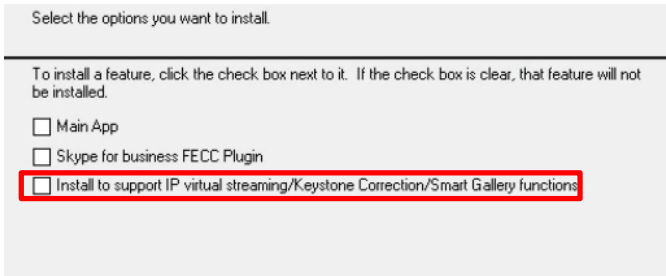

(Windows PC)

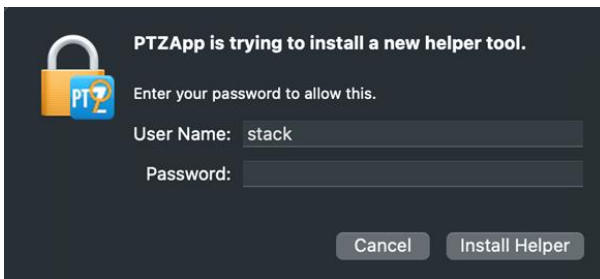

(MAC PC)

Use PTZApp 2 with USB Devices

1. Run your video application and make a video call.
2. During your video call, you can use the PTZApp 2 to pan, tilt and zoom the camera in/out and enable/disable the true WDR, brightness, and sharpness feature.
3. Launch PTZApp 2 () and it will open in Chrome browser automatically.

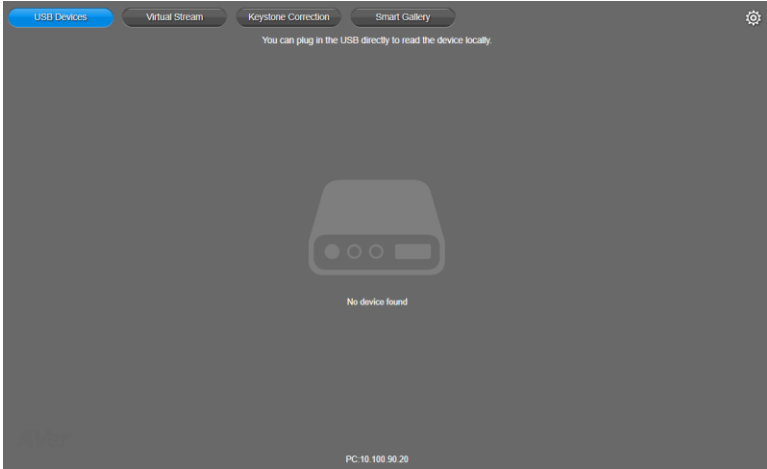

4. Choose "USB devices" and connect VC520 Pro2 to PC/laptop with USB cable. When the camera is detected, the product card will show up.



- 5. Set up IP address. The camera default IP address is **192.168.1.168**. Click pencil icon (✎) to edit IP address.

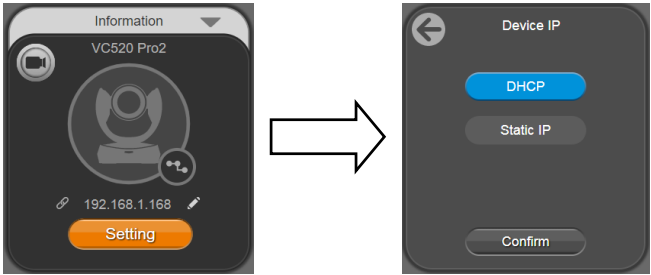

- 6. Click the setting icon to change Language, Hotkey Control, and PTZApp 2 Version.

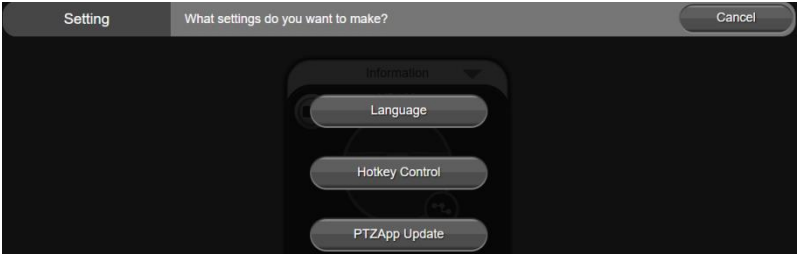
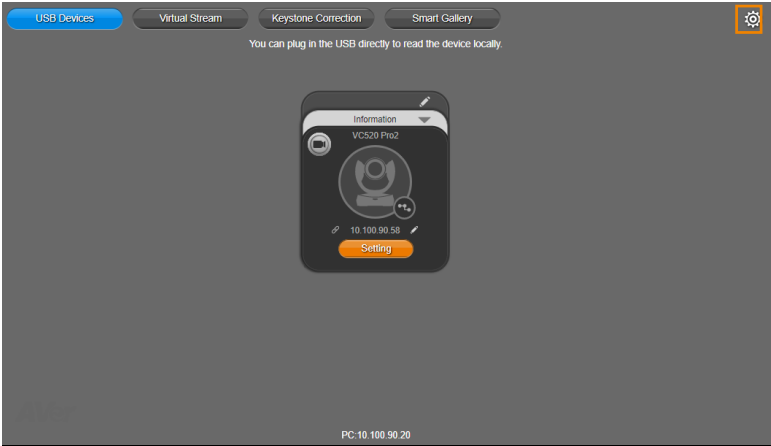

- **Language:** Select desired language and click the check icon to confirm the selection.



- **Hotkey Control:** User can control the camera by using keyboard. This is a general list for all AVer USB Cameras. Backlight control equals to WDR function in VC520 Pro2.

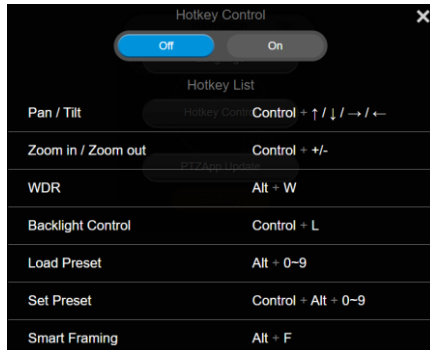

- **PTZApp Update:** Get current PTZApp 2's version number and do auto update here.





7. **Information:** Click the drop-down triangle icon to review the information of camera. To minimize the information, click the triangle or the bottom area of the information icon.

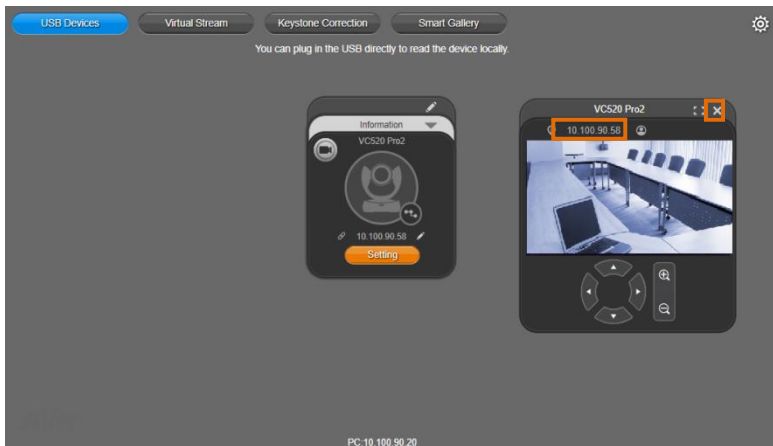
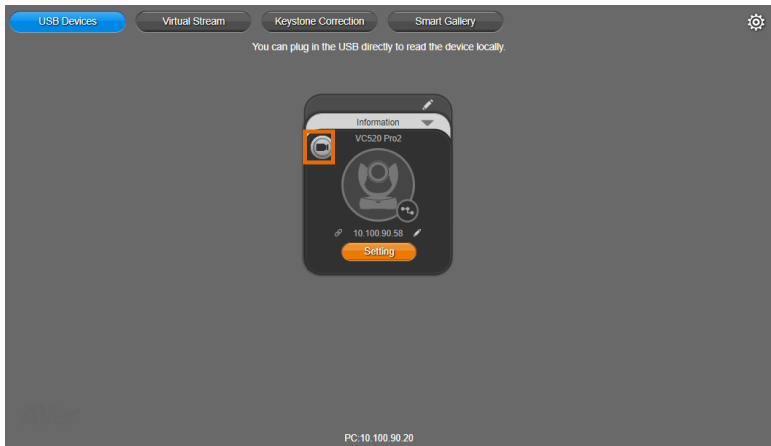

8. **Camera:** Click the camera icon to view the camera live view. IP address is displayed as well. Click the X icon to close the camera live view. If the live video did not appear, please check the camera and the laptop/PC connection to make sure all are correct and well connected.

The resolution of this small live view is 640x480 resolutions.



- **Full Screen:** PTZApp 2 can switch to full screen mode. Click “” icon and video screen will switch to full screen mode. In full screen mode, user can use direction panel to control camera direction. Click “” icon to go back to normal screen view. The resolution of full screen mode is 1080p.

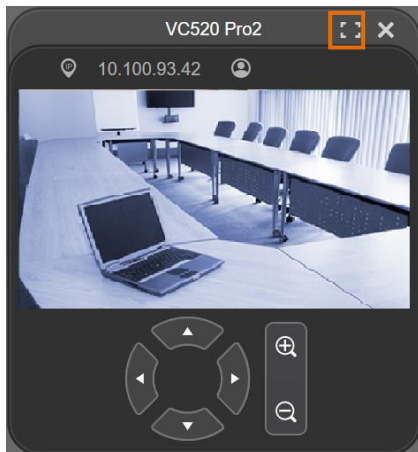

- **People Count and Stream Interval:** Click the  icon to show people count number and stream interval. Click the  or  icon to hide the stream interval.

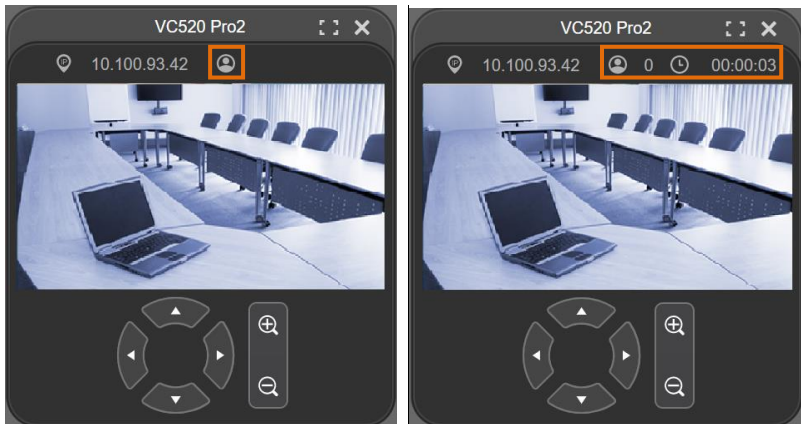

- **Control Panel:** To control the camera direction, zoom in and out during your video call.

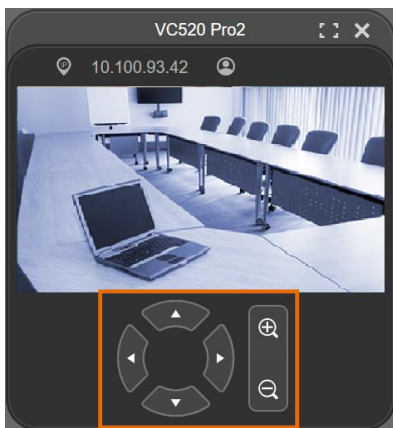

9. **Setting:** Click “**Setting**” button to set up parameters of the camera and speakerphone. Click arrow icon to leave the Setting page.

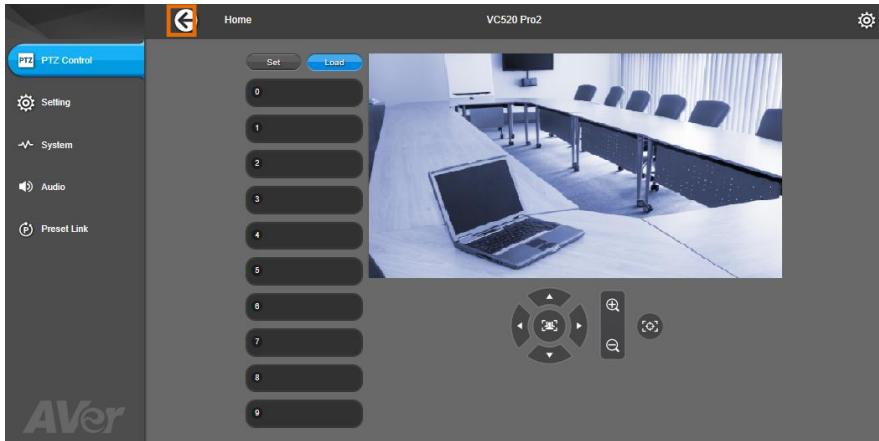
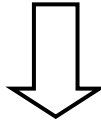
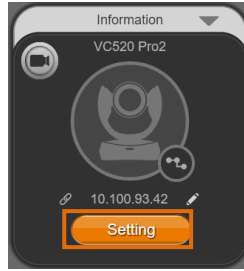

- **PTZ Control:** Use control panel to set up preset positions. Since most of operations are the same as web page, refer to [Set Up the Preset](#) section (page 26) for detailed setup.
- **Setting:** To set up parameters of the camera. Since most of operations are the same as web page, refer to [Camera Settings](#), [Image Settings](#), and [RS232 Settings](#) section (pages 28~40) for detailed setup.
- **System:** To set up system. Since most of operations are the same as web page, refer to [System Settings](#) section (pages 43~48) for detailed setup.
- **Audio:** To set up audio parameters. Since most of operations are the same as web page, refer to [Audio Settings](#) section (pages 49~50) for detailed setup.

The following items are different from web page in **System**.

- **I/O Port:** Except USB port, user can enable or disable all I/O ports.



- **Trouble Shooting:** Click **Start** and **Output** to output log to save in local PC.

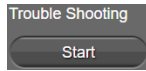

- **Test Speakerphone:** Click **Start** and **Start** to check the speakerphone status. It will require user to record a short message and play it back to ensure the speakerphone is working.

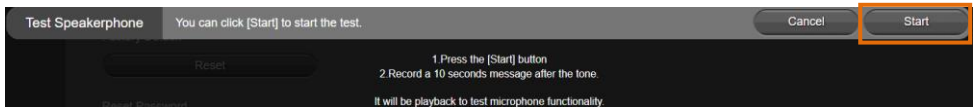
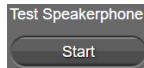

10. Click the icon to display the connected devices to the VC520 Pro2.

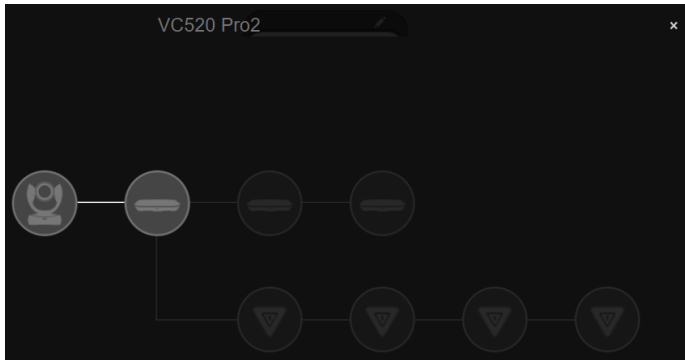
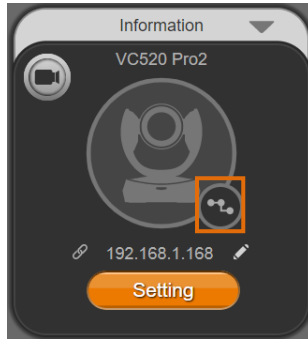

11. **PTZApp 2:** To quit the application, right-click the icon on the system tray and select "**Quit**". If you can't launch PTZApp 2 right after installation, please right-click the icon and choose "**Restore**".

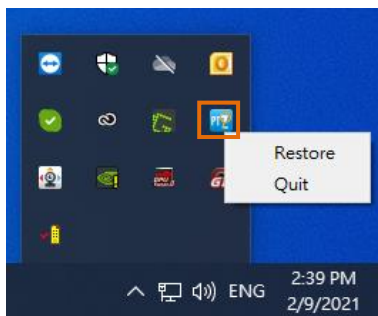

Smart Gallery Operation

You can use the Smart Gallery function to increase the visibility of each participant in the meeting room. When operating Smart Gallery function, please don't open camera view in any other applications.

1. Connect your camera(s) supported with Smart Gallery function to the computer with USB cable.
2. Launch PTZApp 2 () and click **Smart Gallery**, PTZApp 2 will start searching for the camera(s). The searched cameras supported with Smart Gallery function will be displayed.

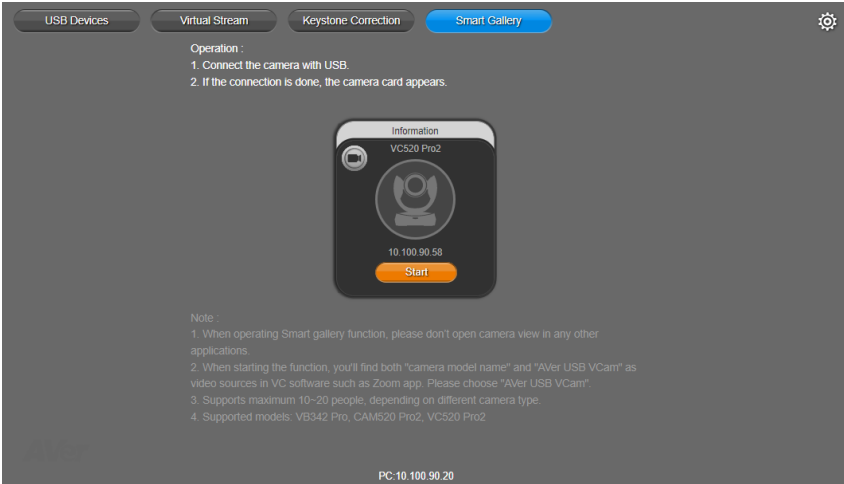

3. Click the **Start** button, the button will change to **Stop**, and you can start operating the Smart Gallery function. To stop the Smart Gallery function, click **Stop**.

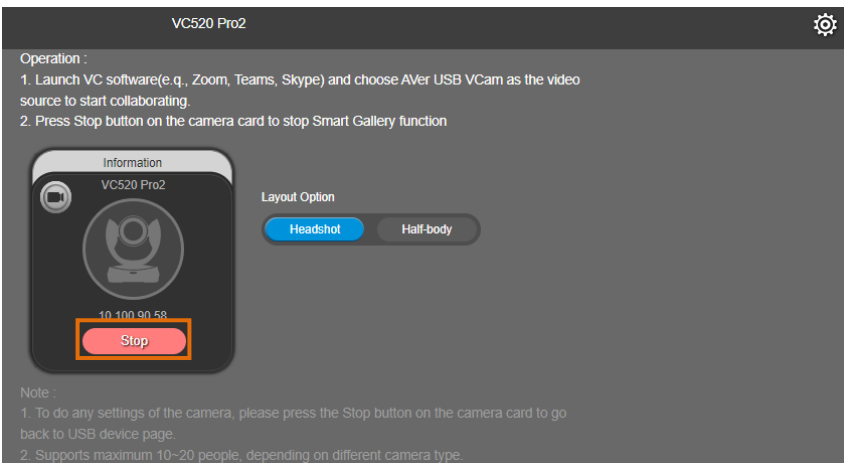

4. Launch VC software (e.g., Zoom, Teams, Skype) and choose AVer USB VCam as the video source to start collaborating. **[Note]** You will find both "camera model name" and "AVer USB VCam" as video sources in the VC software. Please choose "AVer USB VCam".
5. In the **Layout Option** field, click **Headshot** or **Half-body** to perform the function.

Headshot Mode



Half-body Mode



6. To stop the Smart Gallery function, click **Stop**.

[Notes]

- Make sure each person has certain distance to have better image cropping.
- To do any settings of the camera, click the **Stop** button to stop the Smart Gallery function and then go to the **USB Devices** page. Click **Setting** to configure camera settings.
- The Smart Gallery function supports up to 10-20 people, depending on different camera type.

Install EZLive

Please go to <https://www.aver.com/download-center> to download the AVer EZLive software. After downloading, double-click on the file and follow the on-screen instructions to complete the installation.

Use EZLive

During a video call, EZLive can help user to do:

- (1) Camera ePTZ
- (2) Volume control for the speaker connected
- (3) Capture camera's still images
- (4) Record video
- (5) Live stream to YouTube, Livehouse.in, USTREAM...etc.
- (6) Camera Zoom in/out
- (7) Capture PC screen shot
- (8) Record PC screen video
- (9) Set up livestream
- (10) Open file management to retrieve photos and video files
- (11) Livestream setting
- (12) Drawing tool

