

# **AVerVision F70W**

## **User Manual**



## Federal Communications Commission Statement(Class A)



**NOTE-** This equipment has been tested and found to comply with the limits for a Class A digital device, pursuant to Part 15 of the FCC Rules. These limits are designed to provide reasonable protection against harmful interference in a residential installation.

This equipment generates uses and can radiate radio frequency energy and, if not installed and used in accordance with the instructions, may cause harmful interference to radio communications. However, there is no guarantee that interference will not occur in a particular installation. If this equipment does cause harmful interference to radio or television reception, which can be determined by tuning the equipment off and on, the user is encouraged to try to correct the interference by one or more of the following measures:

- Reorient or relocate the receiving antenna.
- Increase the separation between the equipment and receiver.
- Connect the equipment into an outlet on a circuit different from that to which the receiver is connected.
- Consult the dealer or an experienced radio/television technician for help.

### Class A ITE:

Class A ITE is a category of all other ITE which satisfies the class A ITE limits but not the class B ITE limits. Such equipment should not be restricted in its sale but the following warning shall be included in the instructions for use:

**Warning** - This is a class A product. In a domestic environment this product may cause radio interference in which case the user may be required to take adequate measures.

### CE Class A (EMC)



This product is herewith confirmed to comply with the requirements set out in the Council Directives on the Approximation of the laws of the Member States relating to Electromagnetic Compatibility Directive 2014/30/EU.

**Warning** - This is a Class A product. In a domestic environment this product may cause radio interference in which case the user may be required to take adequate measures to correct this interference.

### DISCLAIMER

No warranty or representation, either expressed or implied, is made with respect to the contents of this documentation, its quality, performance, merchantability, or fitness for a particular purpose. Information presented in this documentation has been carefully checked for reliability; however, no responsibility is assumed for inaccuracies. The information contained in this documentation is subject to change without notice.

In no event will AVer be liable for direct, indirect, special, incidental, or consequential damages arising out of the use or inability to use this product or documentation, even if advised of the possibility of such damages.

### TRADEMARKS

“AVer” is a trademark owned by AVer Information Inc. Other trademarks used herein for description purpose only belong to each of their companies.

### COPYRIGHT

©2016 AVer Information Inc. All rights reserved.

All rights of this object belong to AVer Information Inc. Reproduced or transmitted in any form or by any means without the prior written permission of AVer Information Inc. is prohibited. All information or specifications are subject to change without prior notice.

### NOTICE

SPECIFICATIONS ARE SUBJECT TO CHANGE WITHOUT PRIOR NOTICE. THE INFORMATION CONTAINED HEREIN IS TO BE CONSIDERED FOR REFERENCE ONLY.

## **WARNING**

TO REDUCE RISK OF FIRE OR ELECTRIC SHOCK, DO NOT EXPOSE THIS APPLIANCE TO RAIN OR MOISTURE. WARRANTY VOID FOR ANY UNAUTHORIZED PRODUCT MODIFICATION.



THE MARK OF CROSSED-OUT WHEELED BIN INDICATES THAT THIS PRODUCT MUST NOT BE DISPOSED OF WITH YOUR OTHER HOUSEHOLD WASTE. INSTEAD, YOU NEED TO DISPOSE OF THE WASTE EQUIPMENT BY HANDING IT OVER TO A DESIGNATED COLLECTION POINT FOR THE RECYCLING OF WASTE ELECTRICAL AND ELECTRONIC EQUIPMENT. FOR MORE INFORMATION ABOUT WHERE TO DROP OFF YOUR WASTE EQUIPMENT FOR RECYCLING, PLEASE CONTACT YOUR HOUSEHOLD WASTE DISPOSAL SERVICE OR THE SHOP WHERE YOU PURCHASED THE PRODUCT.

## **Remote Control Battery Safety Information**

- Store batteries in any cool & dry place.
- Do not dispose used batteries in domestic waste. Dispose batteries at special collection points or return to stores if applies.
- Remove the batteries if they are not in use for long period of time. Battery leakage and corrosion can damage the remote control, dispose batteries safely.
- Do not mix and use old and new batteries.
- Do not mix and use different types of batteries: alkaline, standard (carbon-zinc) or rechargeable (nickel-cadmium).
- Do not dispose batteries in a fire.
- Do not attempt to short circuit the battery terminals.

# Table of Contents

|  |           |
|--|-----------|
| <b>Package Contents</b> .....  | <b>1</b>  |
| <b>Optional Accessories</b> .....  | <b>1</b>  |
| <b>Get Familiar with the AVerVision F70W</b> .....                         | <b>2</b>  |
| Right Panel .....  | 3         |
| Rear Panel .....   | 3         |
| Left Panel .....   | 4         |
| Control Panel .....  | 5         |
| Remote Control .....   | 7         |
| Making the Connections .....   | 10        |
| Set the TV-RGB Switch Setting .....  | 10        |
| Connect to a Monitor or LCD/DLP Projector with HDMI Output interface ..... | 10        |
| Connect to a TV .....  | 11        |
| Connecting the Power .....   | 11        |
| Connect to a Computer via USB .....  | 12        |
| Connect to a Computer with HDMI Input interface .....                      | 12        |
| Connect an External Microphone .....                                       | 13        |
| Connect an Amplified Speaker .....   | 13        |
| Connect to a Microscope .....  | 14        |
| <b>Connect F70W to WLAN</b> .....  | <b>15</b> |
| <b>Toggling between WiFi mode and USB to PC Mode</b> .....                 | <b>17</b> |
| <b>Connect F70W with a Tablet Device</b> .....                             | <b>17</b> |
| <b>Setting Up AVerVision F70W</b> .....                                    | <b>19</b> |
| Storing and Handling .....   | 19        |
| Shooting Area .....  | 20        |
| Overhead Light .....   | 21        |
| Infrared Sensor .....  | 21        |
| Mounting the F70W on a Flat Surface .....                                  | 22        |
| Anti-glare Sheet .....   | 22        |
| External Memory Storage .....  | 23        |
| Insert an SD Card .....  | 23        |
| <b>OSD MENU</b> .....  | <b>24</b> |
| Navigate the Menu and Submenu .....  | 25        |
| Image .....  | 25        |
| Brightness .....   | 25        |
| Contrast .....   | 25        |
| Mode .....   | 26        |
| Effect .....   | 26        |
| Mirror .....   | 26        |
| Advanced .....   | 26        |

|  |    |
|--|----|
| Auto Image .....                                   | 26 |
| Exposure.....                                      | 27 |
| White Balance.....                                 | 27 |
| Focus.....   | 27 |
| Presentation .....                                 | 28 |
| Spotlight.....                                     | 28 |
| Visor.....   | 28 |
| Split Screen.....                                  | 29 |
| PIP.....   | 29 |
| Timer.....   | 30 |
| Setting .....                                      | 30 |
| Capture.....                                       | 30 |
| Resolution.....                                    | 30 |
| Quality.....                                       | 30 |
| Type.....  | 31 |
| Interval.....                                      | 31 |
| Storage.....                                       | 31 |
| Format.....  | 31 |
| USB to PC.....                                     | 31 |
| Flicker.....                                       | 32 |
| WiFi.....  | 32 |
| Connect.....                                       | 32 |
| Select AP.....                                     | 32 |
| Enter Password.....                                | 33 |
| Connect AP.....                                    | 33 |
| Machine Name.....                                  | 33 |
| System .....                                       | 35 |
| Language.....                                      | 35 |
| Output Display.....                                | 35 |
| Backup.....  | 35 |
| Save Setting.....                                  | 35 |
| Recall Setting.....                                | 35 |
| Information.....                                   | 36 |
| Default.....                                       | 36 |
| Playback.....                                      | 37 |
| Slide Show.....                                    | 37 |
| Interval.....                                      | 37 |
| Slide Show Effect.....                             | 37 |
| Current Storage.....                               | 37 |
| Delete All.....                                    | 37 |
| Transfer Captured Images/Videos to a computer..... | 38 |

- Technical Specifications.....39**
  - Image.....39
  - Optics .....39
  - Compatibility .....39
  - Power .....39
  - Lighting .....39
  - Input/Output.....39
  - Dimension.....40
  - External Storage .....40
- Using the RS-232 Interface.....40**
  - Connect to the Computer RS-232 .....40
- RS-232 Cable Specifications.....40**
- RS-232 Transmission Specifications.....41**
  - RS-232 Communication Format .....41
  - RS-232 Send Command Table .....42
  - RS-232 Get Command Table.....47
- Troubleshooting.....48**
- Limited Warranty.....52**

## Package Contents

Make sure the following items are included in the package.

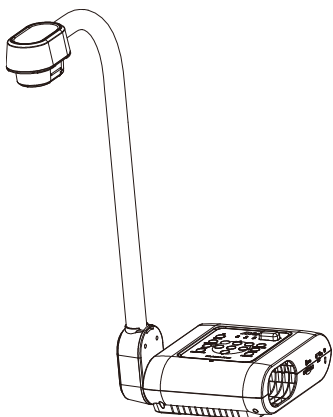

AVerVision F70W



WiFi Dongle

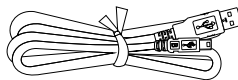

USB Cable

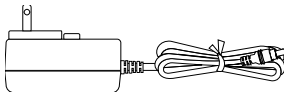

Power Adapter (12V)

\* The power adapter will vary depending on the standard power outlet of the country where it is sold.



Remote Control  
(batteries included)

## Optional Accessories



Carrying Bag

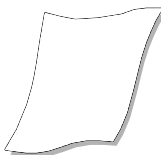

Anti-glare Sheet



Microscope Adapter  
(28mm & 34mm Rubber Coupler)

# Get Familiar with the AVerVision F70W

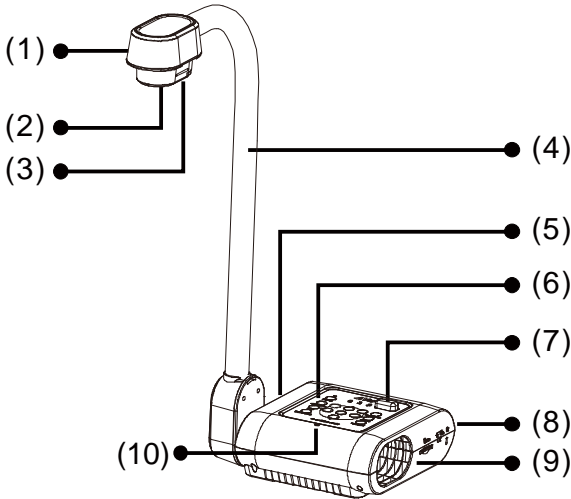

(fig. 1.1)

| Name              | Function   |
|-------------------|--|
| (1) Camera head   | Contain the camera sensor.   |
| (2) Camera lens   | Focus the image in the camera.   |
| (3) LED light     | Provide light to enhance the lighting condition.   |
| (4) Flexible arm  | Provide adjustable viewing coverage.   |
| (5) Left panel    | Connections for RS-232, microphone, speaker, and reset button.   |
| (6) Control panel | Easy access to various functions.  |
| (7) IR sensor     | Receive remote control commands.   |
| (8) Rear panel    | Connections for power, RCA external display device , WiFi dongle, HDMI input, HDMI output and USB to PC.                               |
| (9) Right panel   | Connections for the camera head holder, SD card, TV-RGB display output switch, and antitheft Kensington security lock compatible slot. |
| (10) Built-in MIC | Record audio when recording video clip. The recorded sound will be in monophonic.  |

## Right Panel

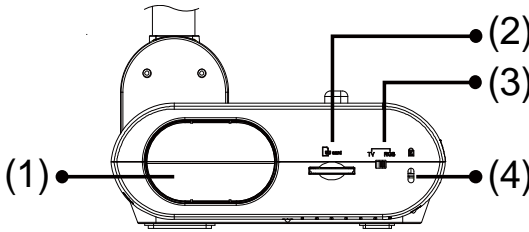

(fig. 1.2)

| Name               | Function  |
|--------------------|---|
| (1) Camera Holder  | Hold the camera head for storage.                                 |
| (2) SD card slot   | Insert the SD card with the label facing up.                      |
| (3) TV-RGB switch  | TV switch to output display video from RCA to HDMI OUT.           |
| (4) Antitheft Slot | Attach a Kensington compatible security lock or antitheft device. |

## Rear Panel

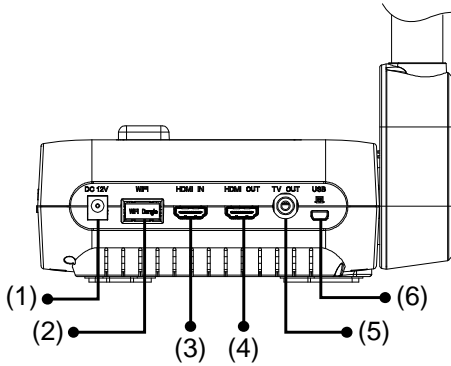

(fig. 1.3)

| Name                 | Function   |
|----------------------|--|
| (1) DC12V            | Connect the power adapter into this port.  |
| (2) WiFi Dongle port | For WiFi dongle connection.  |
| (3) HDMI In port     | Connect an external HDMI source as an input via this port  |
| (4) HDMI Out port    | Output the video signal from the main system on an LCD monitor or LCD/DLP projector with HDMI interface using HDMI cable.  |
| (5) TV Out port      | Connect the AVerVision F70W to any display device with TV output.  |
| (6) Mini USB port    | Connect to a USB port of a computer with a USB cable and use AVerVision F70W as a USB camera or transfer the captured images from the memory source to computer. |

## Left Panel

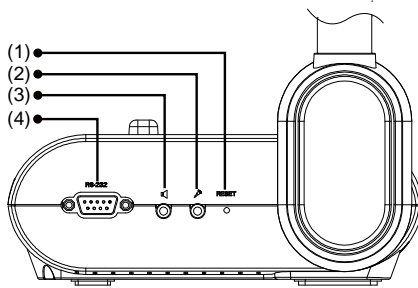



(fig. 1.4)



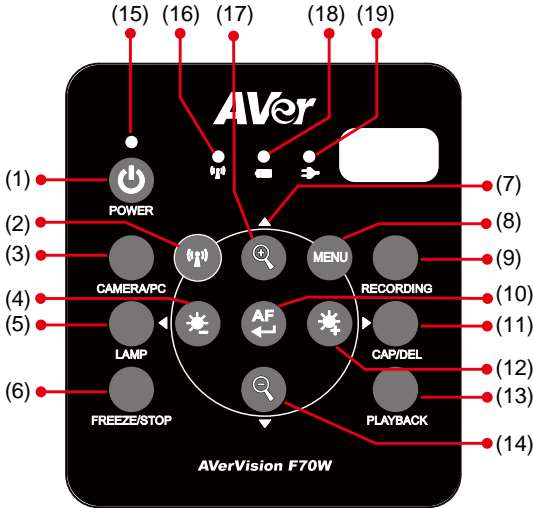



| Name                  | Function   |
|-----------------------|--|
| (1) Reset             | Set system to standby mode.  |
| (2) MIC port          | Connect a 3.5mm plug microphone. The built-in mic will be disabled when an external MIC is connected to this port.       |
| (3) Speaker port      | Connect to an amplified speaker to playback recorded audio & video clip.   |
| (4) RS-232 port Reset | The RS-232 jack is used to connect to computer serial port or to any control panel or for centralized control if desire. |

## Control Panel



(fig. 1.5)

| Name   | Function  |
|--|---|
| (1) POWER  | Turn the unit on/standby mode.  |
| (2)     | Switch between USB mode and WiFi mode.  |
| (3) CAMERA / PC  | Switch the video signal between camera and computer from the HDMI IN port.  |
| (4)     | Reduce the brightness of live view.   |
| (5) LAMP   | Turn the overhead light on/off.   |
| (6) FREEZE/STOP  | <ul style="list-style-type: none"> <li>- Pause or resume image display in Camera mode.</li> <li>- Stop audio &amp; video playback in Playback mode.</li> </ul>  |
| (7) ▲, ▼, ◀, & ▶   | <ul style="list-style-type: none"> <li>- Select options in OSD menu.</li> <li>- Use ▲ &amp; ▼ to increase and decrease the video playback volume.</li> <li>- Use ◀ &amp; ▶ to play the video backward and forward.</li> <li>- Move the Spotlight frame and Visor screen cover.</li> </ul> |
| (8) MENU   | Open and exit the OSD menu.   |
| (9) RECORDING  | Start/Stop audio & video recording. Audio and video recording can be saved on a SD card only. See <a href="#">External Memory Storage</a> .   |
| (10)  | <ul style="list-style-type: none"> <li>- Adjust the focus automatically.</li> <li>- Make a selection in Playback mode and OSD menu.</li> <li>- Start/Pause video playback.</li> </ul>   |

| Name  | Function   |
|---|--|
| (11) CAP/DEL  | <ul style="list-style-type: none"> <li>- Capture picture in Camera mode. In continuous capture mode, press this button again to stop.</li> <li>- Delete the selected picture/video in Playback mode.</li> </ul>  |
| (12)             | Increase the brightness of live view.  |
| (13) PLAYBACK   | View & playback captured still images and video files.   |
| (14)             | Decrease the image magnification in camera and picture playback mode.  |
| (15) Power LED indicator  | <ul style="list-style-type: none"> <li>- <b>Solid Red:</b> Standby</li> <li>- <b>Flashing Red:</b> Power on</li> <li>- <b>Solid Green:</b> HDMI output</li> <li>- <b>Solid Orange:</b> TV output</li> </ul>  |
| (16)  (WiFi)     | <ul style="list-style-type: none"> <li>- <b>Flashing Orange:</b> Search for Access Point</li> <li>- <b>Solid Blue:</b> Connected to Access Point</li> <li>- <b>Flashing Blue:</b> Camera can be accessed wirelessly now</li> </ul>   |
| (17)             | Increase the image magnification in camera and picture playback mode.  |
| (18)  (Battery)  | <ul style="list-style-type: none"> <li>- <b>Solid Green:</b> Battery is over 40%.</li> <li>- <b>Solid Orange:</b> Battery is between 20~40%.</li> <li>- <b>Solid Red:</b> Battery is between 20 ~ 5%.</li> <li>- <b>Flashing Red:</b> Battery is lower than 5%.</li> </ul> |
| (19)  (Charging) | <ul style="list-style-type: none"> <li>- <b>Solid Red:</b> Power plug is connected and battery is charging.</li> <li>- <b>Solid Green:</b> Battery is fully charged.</li> <li>- <b>OFF:</b> Power plug is not connected.</li> </ul>  |

## Remote Control

The remote control requires two (2) “AAA” size batteries (supplied), make sure batteries are installed properly before use. You can access all the features of AVerVision F70W with the remote.

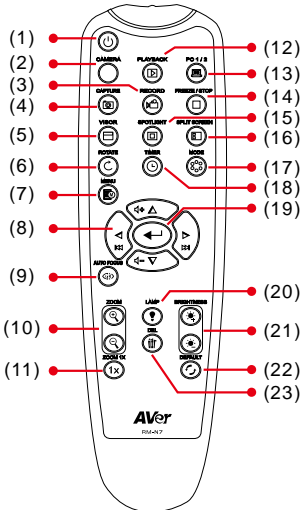

(fig. 1.6)

| Name        | Function  |
|-------------|---|
| (1) POWER   | Turn the unit on.   |
| (2) CAMERA  | Camera mode displays the video signal from the built-in camera.   |
| (3) RECORD  | Start/Stop audio & video recording. Video recording can only be saved either in a SD memory card.   |
| (4) CAPTURE | Capture still image in Camera mode. In continuous capture mode, press this button again to stop.  |
| (5) VISOR   | Call the Visor submenu. Visor covers part of the presentation screen and allow presenter to reveal the material as desire.<br>In the Visor submenu, the following options are available.<br><div data-bbox="644 699 879 877" data-label="Image"> </div> |
| (6) ROTATE  | Rotate the image by 180° in Camera mode and Playback mode.  |
| (7) MENU    | Open and exit the OSD menu.   |

**ON/OFF** – select to run/cancel the Visor.

Press to move to the next selection.

**Shade** – set the opacity level of the covered area. The shaded area will completely turns black when it is set to level 100. Press to move to the next selection.

**OK** – press for the setting to take effect. If you select ON, upper part of the presentation screen is slightly exposed. Use the **▲**, **▼**, **◀**, & **▶** buttons to reveal more of the covered area; and OFF will close the submenu.

To turn off Visor, press again.

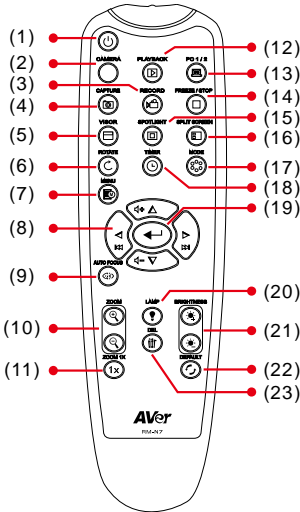

(fig. 1.6)

| Name               | Function   |
|--------------------|--|
| (8) ▲, ▼, ◀, & ▶   | <ul style="list-style-type: none"> <li>- Pan and zoom-in image (above digital zoom level) in both live and playback mode.</li> <li>- Select options in OSD menu.</li> <li>- Use ▲&amp;▼ to increase and decrease the video playback volume.</li> <li>- Use ◀&amp;▶ to play the video backward and forward.</li> </ul> <p>Move the Spotlight frame and Visor screen cover.</p>  |
| (9) AUTO FOCUS     | Adjust the focus automatically.  |
| (10) ZOOM +/-      | Increase/decrease the image magnification in camera and picture playback mode.   |
| (11) ZOOM RESET    | Reset zoom level to 100%.  |
| (12) PLAYBACK      | View the captured picture/video from the memory in 16-thumbnail images.  |
| (13) PC 1/2        | PC mode displays the video signal from the HDMI input port of F70W.  |
| (14) FREEZE / STOP | <ul style="list-style-type: none"> <li>- Freeze live images.</li> <li>- Stop video playback.</li> </ul>  |
| (15) SPOTLIGHT     | <p>Call the Spotlight submenu. Spotlight overlays a box frame on the presentation screen. You can adjust the box size and move it around.</p> <p>In the Spotlight submenu, the following options are available.</p> <div data-bbox="640 932 868 1109" data-label="Image"> <p>The screenshot shows the 'SpotLight' OSD menu. It has a title bar 'SpotLight' and two buttons: 'OFF' and 'ON'. Below that is a 'Shade' slider with a value of 6. Underneath is a 'Color' selection with three color swatches: red, green, and blue. At the bottom, there is an 'OK' button.</p> </div> <ul style="list-style-type: none"> <li><b>ON/OFF</b> – select to run/cancel the Spotlight. Press ◀ to move to the next selection.</li> <li><b>Shade</b> – set the opacity level of the area outside the box. The shaded area will completely turns black when it is set to level 100. Press ◀ to move to the next selection.</li> <li><b>Color</b> – select the Spotlight frame color. Press ◀ to move to the next selection.</li> </ul> |

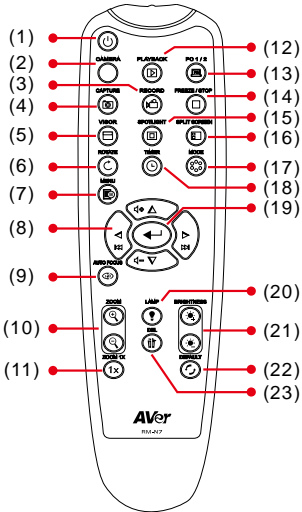

(fig. 1.6)





| Name                | Function  |
|---------------------|---|
| (15) SPOTLIGHT      | <b>OK</b> – press  for the setting to take effect. If you select ON, the frame will appear and blink, use the , , , &  buttons to adjust the frame size and press  to set the desired size; and OFF will close the submenu.<br>To turn off Spotlight, press  again. |
| (16) SPLIT SCREEN   | Divide the screen into two. One side displays the live image from the built-in camera and the other side displays 8-thumbnailed size picture/video from the memory.   |
| (17) MODE           | Select from 3 type of modes:<br><b>Text</b> - adjust the contrast along the edges making text appear more visible.<br><b>Graphics</b> - adjust the gradient of image.<br><b>Microscope</b> - automatically adjust optical zoom for microscopic viewing.             |
| (18) TIMER          | Call the Timer submenu. Select to Start/Pause/Stop the timer countdown and set the timer duration.<br>  |
| (19)                | - Make a selection in Playback mode and OSD menu.<br>- Play/Pause video playback.   |
| (20) LAMP           | Turn the overhead light on/off.   |
| (21) BRIGHTNESS +/- | Adjust the brightness.  |
| (22) DEFAULT        | Reset to factory default setting.   |
| (23) DEL            | Delete the selected picture/video in Playback mode.   |

## Making the Connections

Before making the connection, make sure the power of all devices are turned off. If you are not sure on where to connect, simply follow the illustrated connections below and also refer to the user manual of the device you are connecting the AVerVision F70W with.

### Set the TV-RGB Switch Setting

The TV-RGB switch determines the display output selection. Switch it to RGB (right) to output signal using HDMI connection and TV (left) to output signal using RCA connection. (see fig. 1.2 # 3)

| Switch | AVerVision Port  |    | Display Device Port   |
|--------|--|----|---|
| RGB    | <br>HDMI OUTPUT | To | <br>HDMI INPUT |
| TV     | <br>TV OUTPUT   |    | <br>VIDEO IN   |

### Connect to a Monitor or LCD/DLP Projector with HDMI Output interface

Locate the HDMI input port of the display device and connect it to HDMI out port of AVerVision F70W.



Make sure the TV/RGB switch is set to RGB.

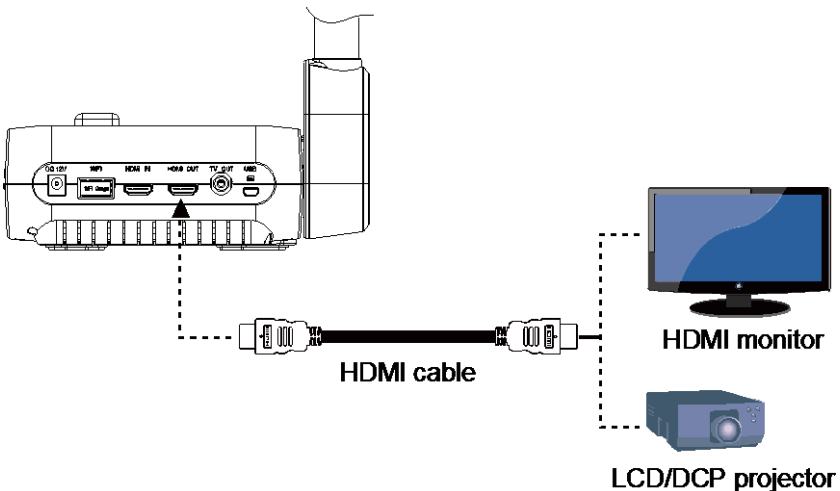

## Connect to a TV

Locate the Video input port of the TV or Video equipment (i.e., VCR) to record your presentation and connect it to RCA jack of RCA cable.

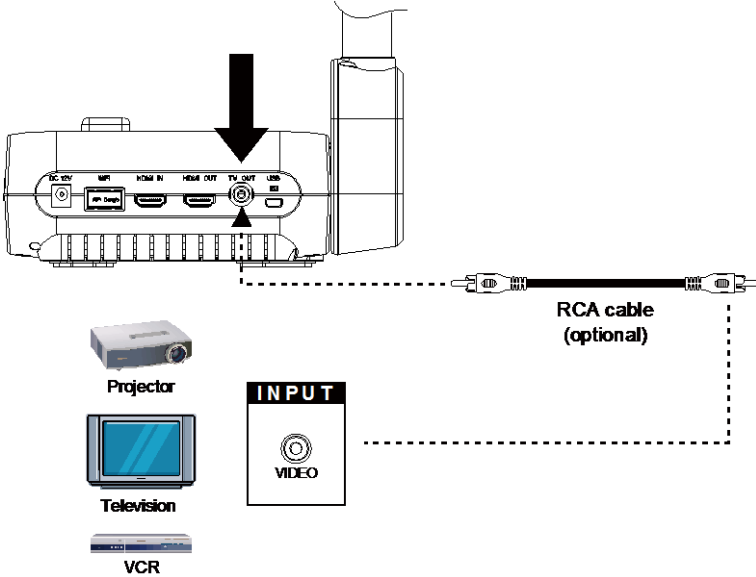

## Connecting the Power

Connect the power adapter (12V) to a standard 100V~240V AC power outlet. The unit automatically goes into standby mode once the power is connected. Press  to turn on.

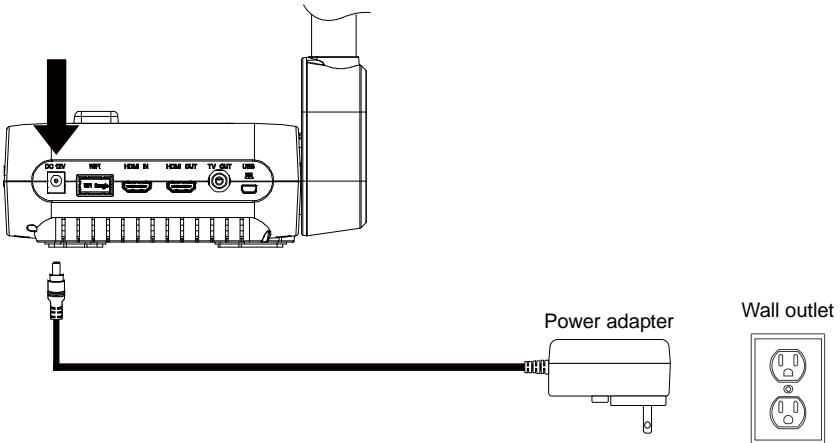

## Connect to a Computer via USB

Locate the USB port of the computer or laptop and connect it to the PC port of the AVerVision F70W.

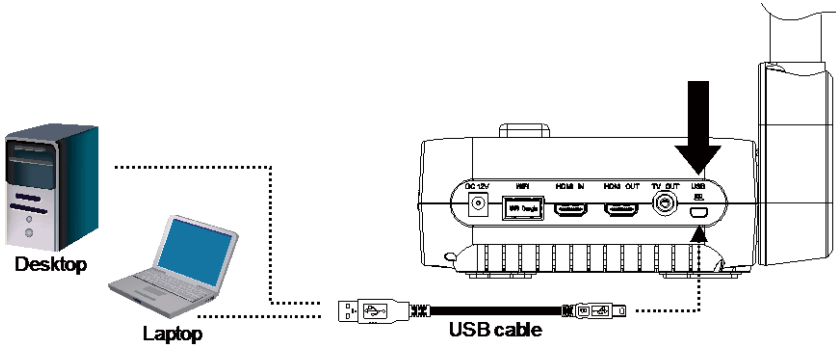

## Connect to a Computer with HDMI Input interface

Locate the HDMI output port of the computer or laptop and connect it to HDMI in port of AVerVision F70W.



- Make sure the TV/RGB switch is set to RGB.
- To display computer image, press Camera/PC button on the control panel or remote control to switch AVerVision F70W to computer mode.
- For laptop to output display image, use the keyboard command (FN+F5) to switch between the display modes. For different command, please refer to your laptop manual.

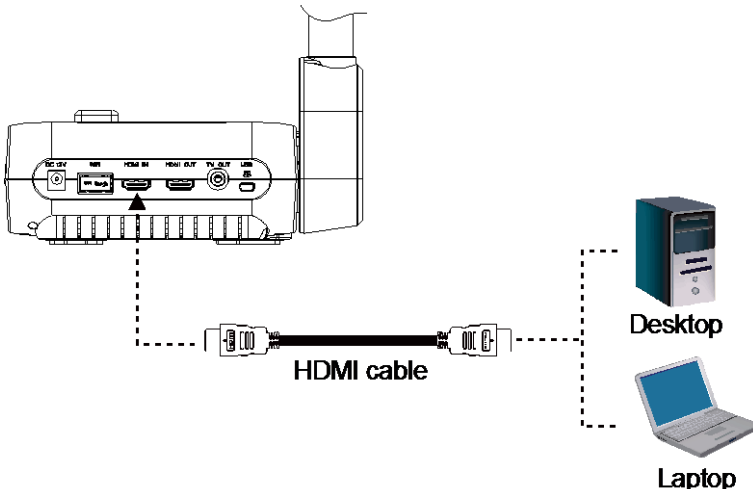

## Connect an External Microphone

Plug a 3.5mm mono microphone to  port. The built-in microphone on the control panel will be disabled when an external microphone is connected. The recorded audio will be in monophonic sound.

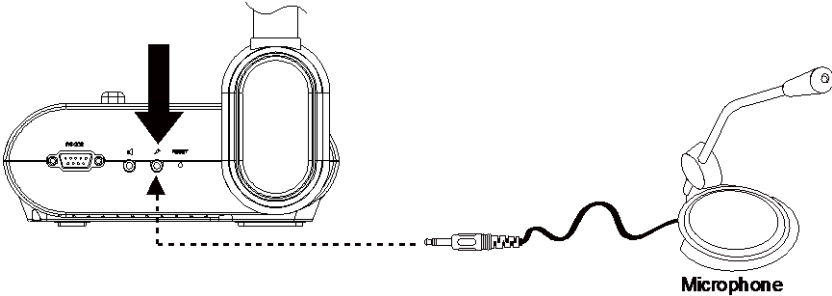

## Connect an Amplified Speaker

Plug a 3.5mm plug amplified speaker to  port. Only the audio from the video playback is supported.



We recommend connecting an amplified speaker to the Audio output port. Take caution when using earphones. Adjust the volume down on the remote to prevent hearing damage due to loudness.

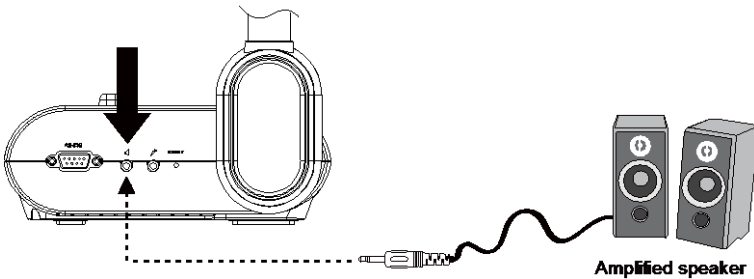

# Connect to a Microscope

Connect the AVerVision F70W to a microscope enables you to examine microscopic objects on a big screen.

1. Change the image display mode to Microscope. Press **MENU** > select **IMAGE** tab > select **MODE** > select **(microscope)** and press **↩**.



2. Aim the camera head at the farthest point and press **AUTO FOCUS**.

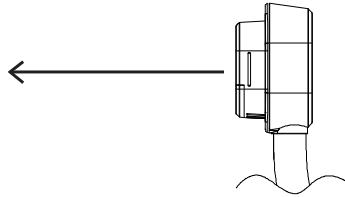

3. Adjust the focus of the microscope.

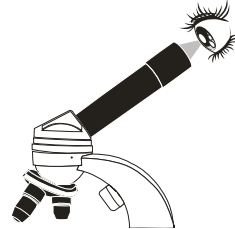

4. Select the appropriate rubber coupler size for the microscope eyepiece and insert it in the microscope adapter.

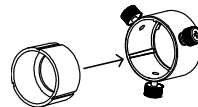

5. Remove the microscope eyepiece from the microscope and connect it to the microscope adapter with the rubber coupler inserted. Fasten the 3 bolts until the adapter secures the eyepiece.

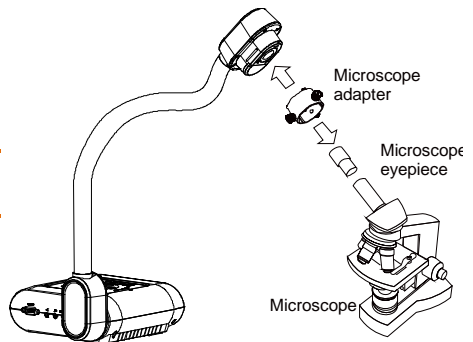

For the eyepiece, we suggest using 15.5mm eye relief or higher.

6. Attach the microscope adapter to the AVerVision camera head. Then connect it to the AVerVision and microscope.

Make sure the arrow on the camera head and microscope adapter are on the same side to connect and twist clockwise for the arrows to meet and lock.

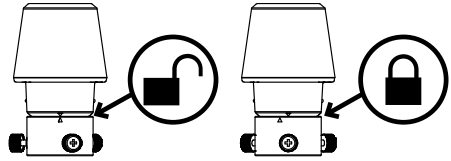

## Connect F70W to WLAN

The F70W can connect to your WLAN network through the WiFi function.

1. Press **Menu** button.

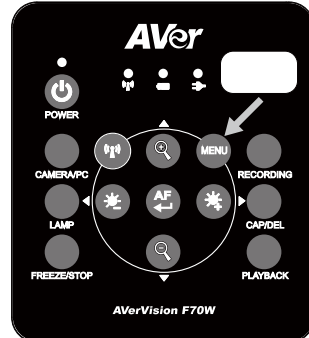





2. Select **WiFi** setup page.





3. Select **Connect** and press .

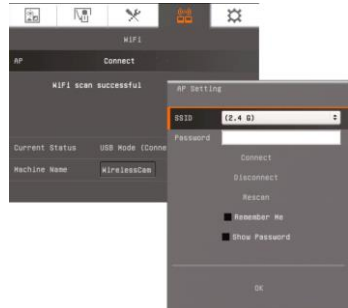

- In AP setting submenu, select SSID(AP) that the F70W has found on your WLAN. Press  and use  and  to select. Press  to confirm the selection.



- Enter the **Password** of selected AP. Use  to move to the Password column and press  to call out on-screen keyboard to enter the password.

**[Note] Show Password** is enabled by default. User can see the password while entering.



- After entering password, select **“Connect”** and press  to make a connection with selected AP.

To disconnect the WiFi connection, select **“Disconnect”** and press .

To memorize the AP account, enable **“Remember Me”** function. By default, this function is enabled.

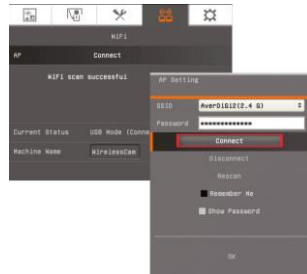

- When AP information is displayed, the connection is successful.

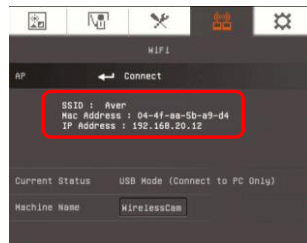

## Toggle between WiFi mode and USB to PC Mode

The F70W HDMI output is always on, however the camera can only be put into either USB to computer mode (when the USB cable is connected to a computer) or WiFi mode.

When the WiFi button on the front panel of the camera is not toggled, the camera is always in USB to PC mode whenever the cable is connected to the computer. However once the WiFi button is toggled (assuming the WiFi setting is complete and correct), the camera goes into WiFi mode and will disconnect the existing USB connection to the computer. In WiFi mode you can still connect to the camera via Wireless Streaming through the AVer PC/MAC software or Tablet computer.

## Connect F70W with a Tablet Device

This function allows the user to stream, present, annotate, record and share live images via a tablet device. The following instruction figures use an iPad as an example.

1. Please make sure the F70W and tablet are connected to the same AP on your WLAN network.
2. Install “Sphere” application on the tablet.

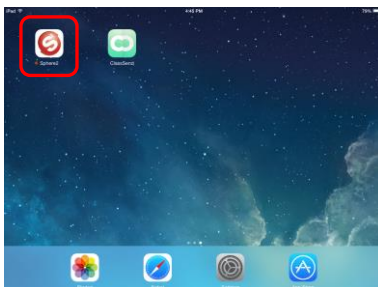

3. Run Sphere application. In Sphere UI, user will see the DocCams that Sphere has found.



4. Select the DocCam and select **“Start”** to make a connection.

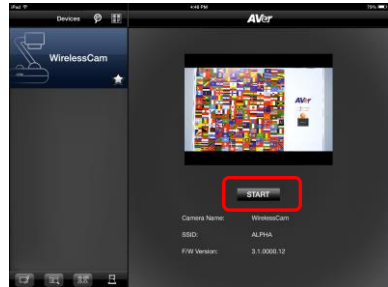

5. After connection is successful, users will see the live image of the DocCam.



## Setting Up AVerVision F70W

This section provides useful tips on how to adjust the AVerVision F70W to meet your needs.

### Storing and Handling

The gooseneck design allows you to freely bend the arm and store the camera head in the camera holder. Once you have properly secured the camera head to the camera holder, you may use the arm to carry AVerVision F70W.

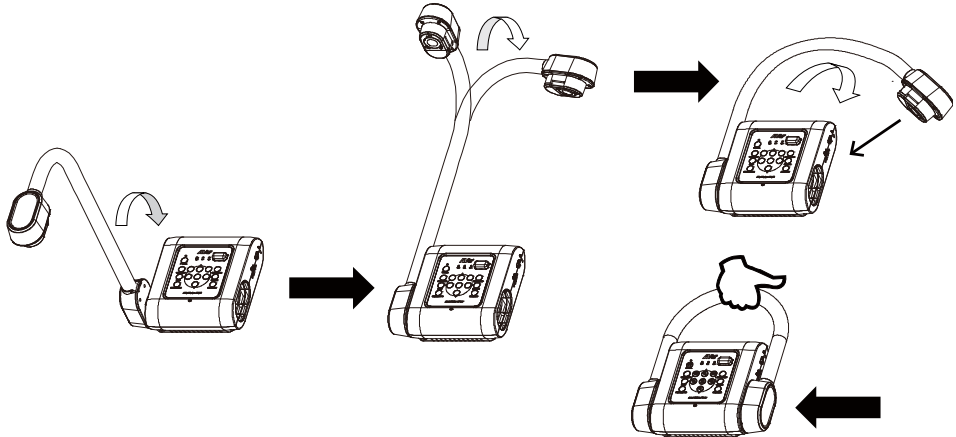

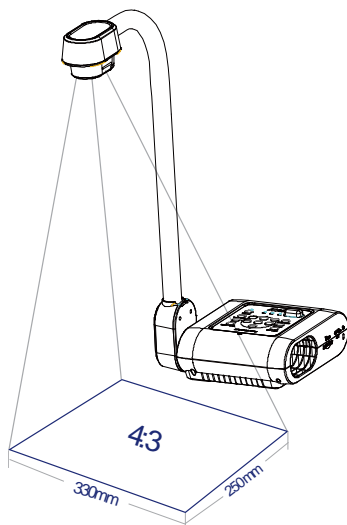

## Shooting Area

The shooting area can view an area of 330x250mm (4:3) size portrait paper.

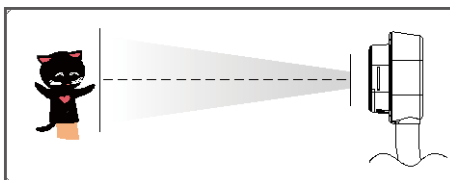

If the camera head is in upright position, press ROTATE on the control panel or remote control to rotate the image in 180°.



To mirror the image, press MENU > select Mirror, press , and select On.

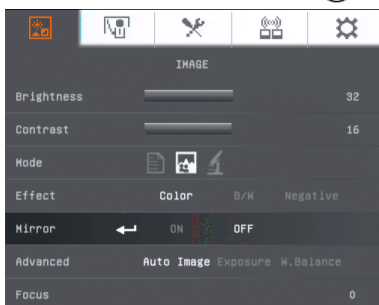

## Overhead Light

Press LAMP button on the control panel or remote control to turn on and off light.

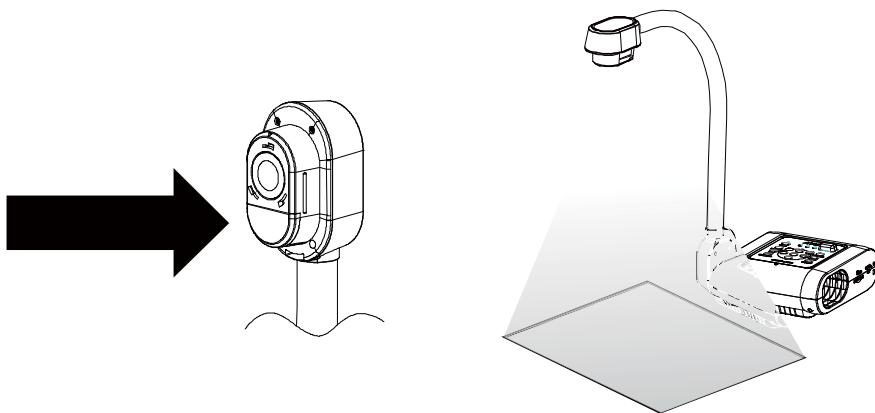

## Infrared Sensor

Aim the remote control at the infrared sensor to operate the unit.

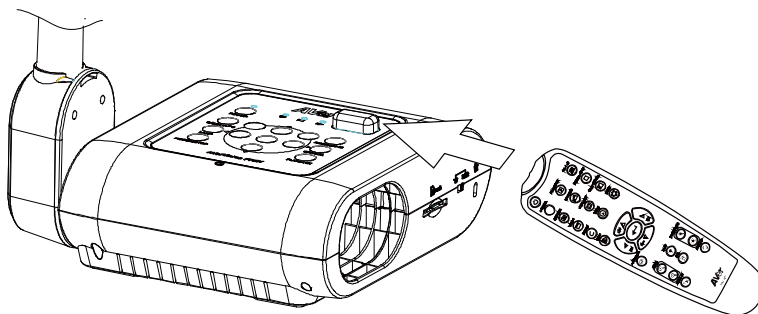

## Mounting the F70W on a Flat Surface

Measure and mark the horizontal of 75 mm from the center line distance between the holes on the flat surface as describe in the illustration below. Use 2 pieces of M4.0 screws for 6 mm holes and secure the F70W on the flat surface.

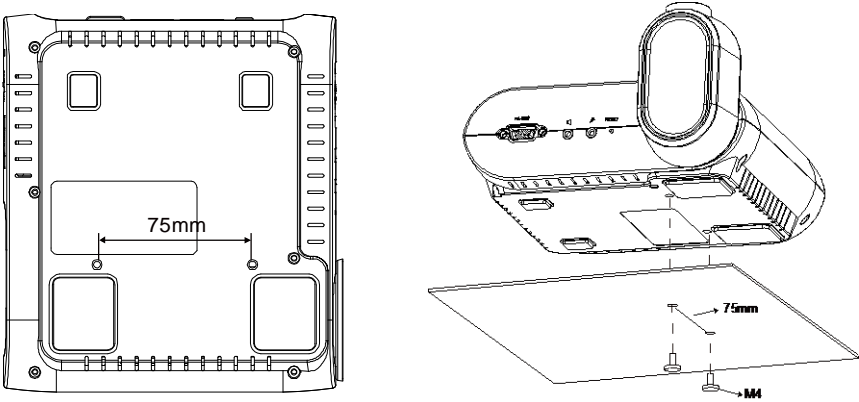

## Anti-glare Sheet

The anti-glare sheet is a special coated film that helps eliminate any glare that maybe encountered while displaying very shiny objects or glossy surfaces such as magazines and pictures. To use, simply place the anti-glare sheet on top of the shiny document to reduce reflected light.

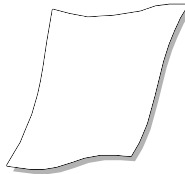

# External Memory Storage

AVerVision F70W supports an external SD memory card for more image capture and audio & video recordings. AVerVision F70W can detect when there is an external storage media and automatically switch to the last detected storage. If no external storage is connected, all captured still images will be saved in the built-in memory.

### [Note]

Generally you can use the F70W to do video recording for as long as you would like depending on how much SD Card memory is being used (up to 32GB). Recording is done in 1080p 30fps into an MP4 format.

A one hour recording could generate a file as large as 1.2 to 1.5 gigabyte (Gb) of disc space. The system will automatically truncate the video file into multiple files once the size reaches 2Gb of space. For instance, if your 3 hour video recording takes up to 3Gb of space, you will have 2 video recorded files being generated, the first one 2Gb and the second file 1Gb for a total of 3Gb.

### Insert an SD Card

Insert the card with the contact facing down until it reaches the end. To remove the card, push to eject and pull the card out. The supported SD card capacity is from 1GB to 32GB (FAT32). We recommend using SDHC card with class-6 or above for high quality recording.

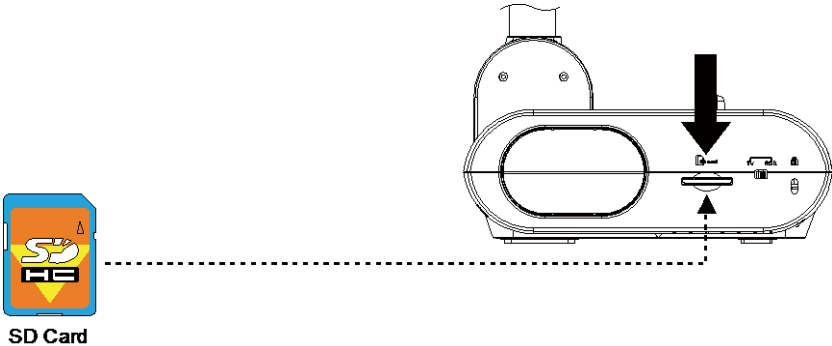

# OSD MENU

There are 5 tabs on the OSD menu: IMAGE, PRESENTATION, SETTING, WIFI, and SYSTEM. In Playback mode, you can access PLAYBACK OSD menu to enable the Slide Show feature and modify Slide Show interval and transition setting if desire.



For TV output, the RESOLUTION will be disabled in SETTING menu list.

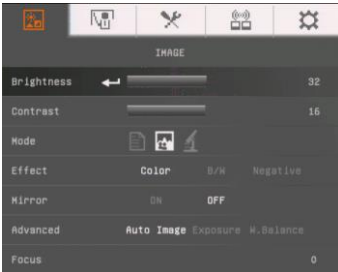

IMAGE

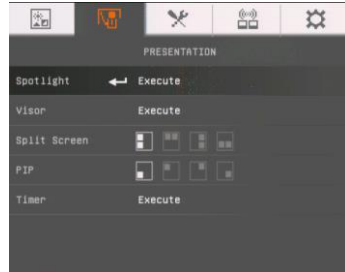

PRESENTATION

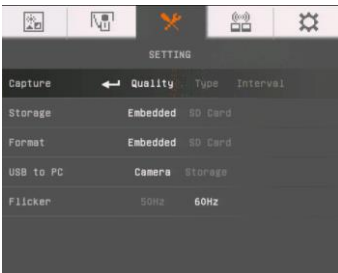

SETTING

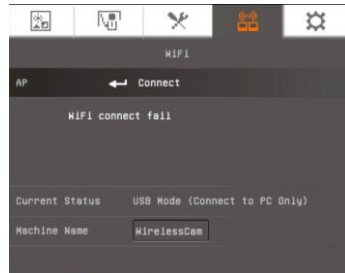

WIFI



SYSTEM

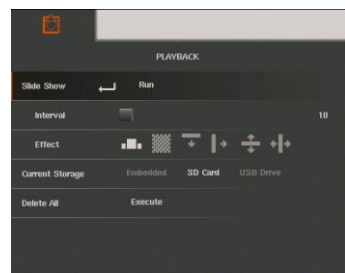

PLAYBACK

# Navigate the Menu and Submenu

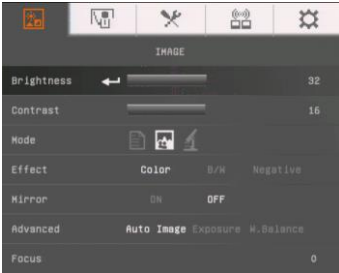

1. Press MENU button on the remote or control panel.
2. Press ► and ◀ to toggle between tabs
3. Press ▼ and ▲ to choose a selection in the menu list.
4. Press ↶ to make a selection.
5. Use ► and ◀ to adjust the setting or make a selection.
6. Press ↶ to enter submenu.
7. Press MENU to close the OSD menu.

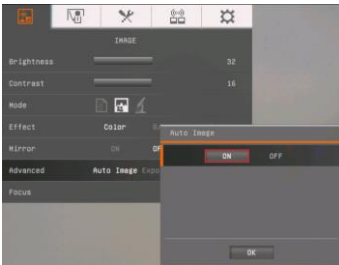

## Image

### Menu Screen

### Function



#### Brightness

Adjust brightness level manually between 1 and 64.

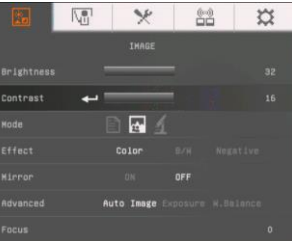

#### Contrast

Adjust the contrast level manually between 1 and 32 under bright and dark environments.

## Menu Screen

## Function



### Mode

Select from the various image display settings.

 **Text** - adjust the contrast along the edges making text appear more visible.

 **Graphics** - adjust the gradient of image.

 **Microscope** - automatically adjust optical zoom for microscopic viewing.



### Effect

Convert the image into positive (true color), monochrome (black and white) or negative.



### Mirror

Select to flip the image in Camera mode.

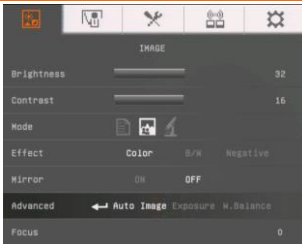

### Advanced

Select to set the Auto Image, Exposure, and White Balance settings.

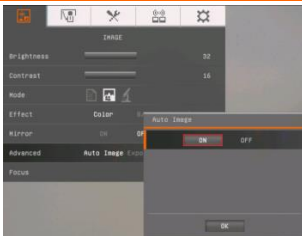

### Auto Image

Select ON or OFF to automatically adjust the white balance and exposure setting, and correct the color and exposure compensation.

## Menu Screen

## Function

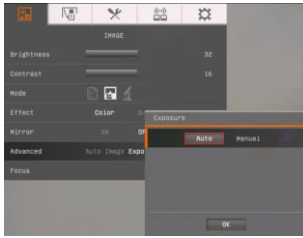

### Exposure

Select the exposure setting.

**AUTO** - automatically adjust the camera exposure and the amount of light required.

**MANUAL** - manually adjust the exposure level. The exposure can be adjusted up to 99.

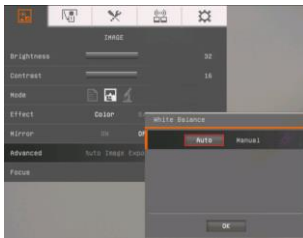

### White Balance

Select the White Balance setting for various light conditions or color temperature.

**AUTO** - automatically adjust the white balance.

**MANUAL** - manually adjust the red and blue color level. The color level can be adjusted up to 255.



### Focus

Manually adjust the focus.

# Presentation

## Menu Screen

## Function

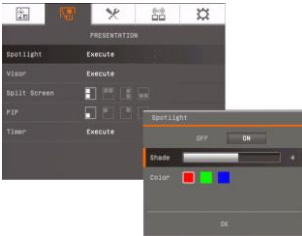

### Spotlight

Spotlight overlays a frame on the presentation screen. You can move the Spotlight around the presentation screen using the ▲, ▼, ◀, & ▶ buttons. Select Execute to call the Spotlight submenu.



In the Spotlight submenu, the following options are available.



**ON/OFF** – select to run/cancel the Spotlight. Press ◀ to move to the next selection.

**Shade** – set the opacity level of the area outside the box. The shaded area will completely turns black when it is set to level 100. Press ◀ to move to the next selection.

**Color** – select the Spotlight frame color. Press ◀ to move to the next selection.

**OK** – press ◀ for the setting to take effect. If you select ON, the frame will appear and blink, use the ▲, ▼, ◀, & ▶ buttons to adjust the frame size and press ◀ to set the desired size; and OFF will close the submenu.

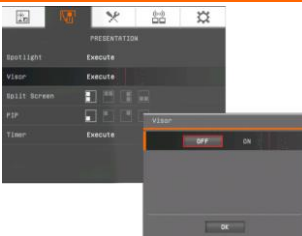

### Visor

Visor covers the presentation screen. The upper part of the presentation screen is slightly exposed. Use the ▲, ▼, ◀, & ▶ buttons to reveal more of the covered area. Select Execute to call the Visor submenu.

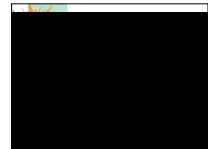

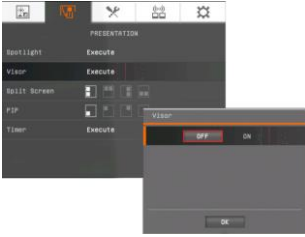

## Menu Screen

## Function



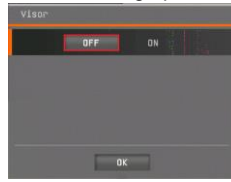





In the Visor submenu, the following options are available.



**ON/OFF** – select to run/cancel the Visor. Press  to move to the next selection.

**Shade** – set the opacity level of the covered area. The shaded area will completely turn black when it is set to level 100. Press

 to move to the next selection.

**OK** – press  for the setting to take effect. If you select ON, upper part of the presentation screen is slightly exposed. Use the , , , &  buttons to reveal more of the covered area; and OFF will close the submenu.

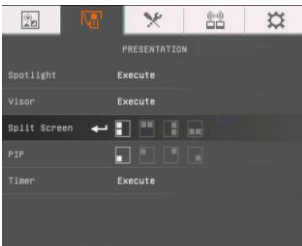

### Split Screen

Divide the screen into two parts. Half of the screen displays the 8-thumbnail images and the other half display the image from the AVerVision F70W camera.

Select the display location of the 8- thumbnail playback images. Select OFF to cancel Split Screen.



Left



Right



Top



Below

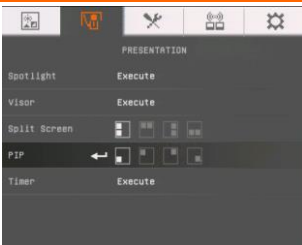

### PIP

Select the thumbnail playback screen location and show the thumbnail playback screen at the corner of the screen to recall the captured image from the memory in Camera mode. Select OFF to cancel PIP.



Lower Left



Upper Left



Upper Right



Lower Right

## Menu Screen

## Function

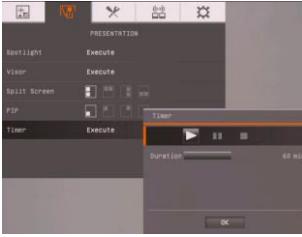

### Timer

Start/Pause/Stop the timer and set the timer duration. The timer automatically counts up after the count down reaches zero to show the elapsed time. Even when you switch between Playback, PC or Camera modes, the timer will continue.

## Setting

## Menu Screen

## Function

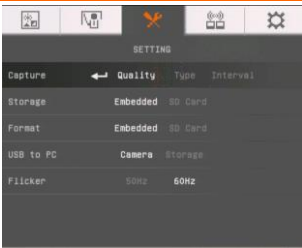

### Capture

Select to set the capture resolution, quality, type and interval settings.

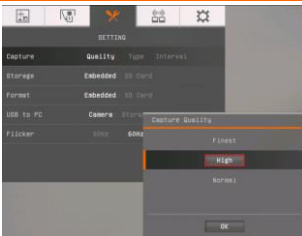

### Resolution

Select the capture size. In 2M setting, the capture resolution size is 1920 X 1080.

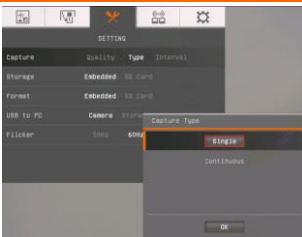

### Quality

Select the capture compression setting.

## Menu Screen

## Function

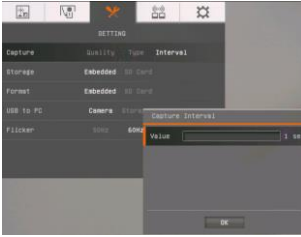

### Type

Select the capture type.

**Single** - capture one picture only.

**Continuous** - capture successive pictures.

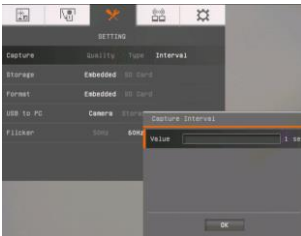

### Interval

Set the time interval for continuous capture. The length can be set up to 600 sec (10 min).

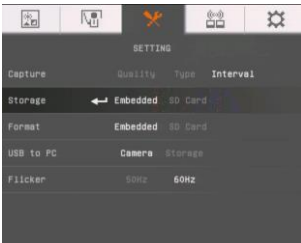

### Storage

Change the storage location. Audio & video recording can only be saved in SD memory card.

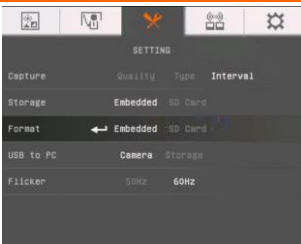

### Format

Format to delete all the data in the selected memory.

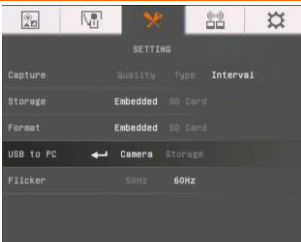

### USB to PC

**Camera** - can be used as a computer webcam or with our bundled software to record video and capture still image.

**Storage** - transfer the captured pictures/videos from the memory to computer hard disk.

## Menu Screen



## Function

### Flicker

Select between 50Hz or 60Hz. Some display devices cannot handle high refresh rates. The image will flicker a couple of times as the output is switched to another refresh rate.

## WiFi

## Menu Screen





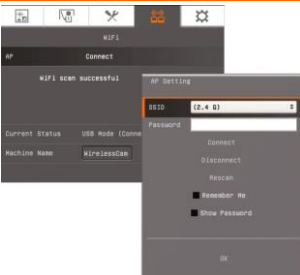

## Function

### Connect

Select AP, enter Password of AP, and make a connection with selected AP.



### Select AP

Press  to expand AP list that F70W has detected on your LAN network. Use  and  buttons to move to the AP that you want to select. Press  to confirm.

## Menu Screen



## Function

### Enter Password

Use ▼ button move to password column. Press ⌂ to call out on-screen keyboard. Use ▲, ▼, ◀, ▶ & ⌂ to select the password. Use the “Back” key to delete unwanted characters. When is done, select Enter to complete. If you want check password during enter password, mark **Show Password** option.

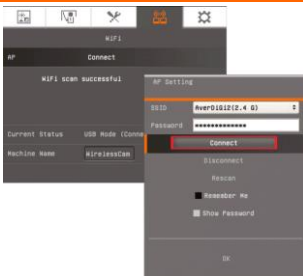
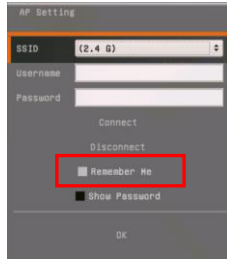

### Connect AP

Use ▼ button move to “**Connect**” and press ⌂ to start connection. When connection is successful, the AP information is displayed.

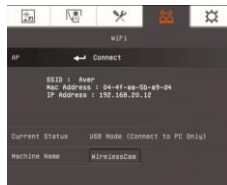

To disconnect, select “**Disconnect**” and press ⌂.  
To remember this AP account, mark **Remember Me**.  
To back to WiFi page, select “**OK**” and press ⌂.

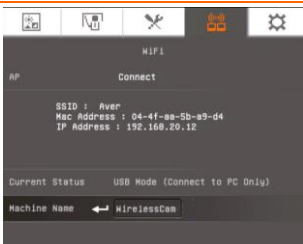

### Machine Name

Give a name for the DocCam. Use ▼ button move to “**Machine Name**” and press ⌂ to call out on-screen keyboard. Then, Use ▲, ▼, ◀, ▶ & ⌂ to enter the name. This name will be an identity in Sphere application for user to recognize.



# System

## Menu Screen

## Function

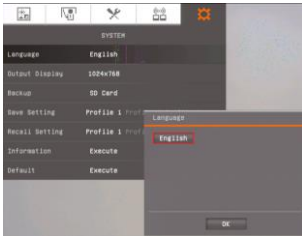

### Language

Change and select a different language.

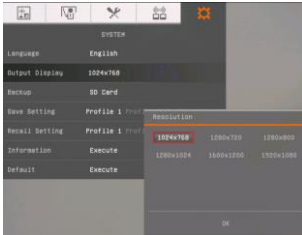

### Output Display

Set the resolution to display the image on screen. This selection will be disabled in TV output mode.



### Backup

Copy the image from the built-in memory to SD card.

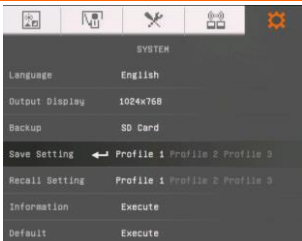

### Save Setting

Save current setting in the selected profile number. Only effect, mode, brightness and contrast settings can be saved.

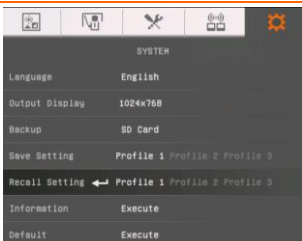

### Recall Setting

Restore the setting back to the selected profile number.

## Menu Screen

## Function

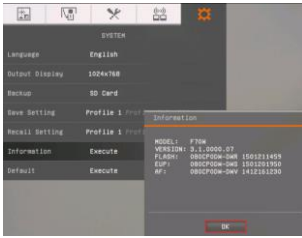

### Information

Display the product firmware version information.



### Default

Restore all the settings into original factory default.

# Playback

## Menu Screen

## Function

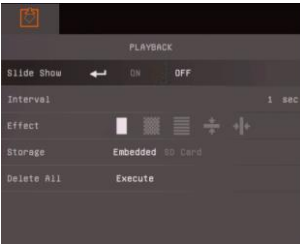

### Slide Show

Display all captured still pictures in an automated slide show. The video file will be skipped.

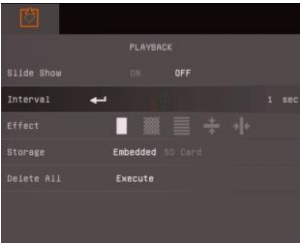

### Interval

Set the interval before displaying the next picture. The length can be set up to 100 sec.

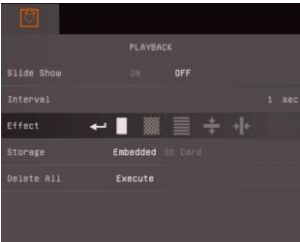

### Slide Show Effect

Select the slide show transition effect.



Slide image



Split Vertical Out



Checker down



Split Horizontal In



Blinds

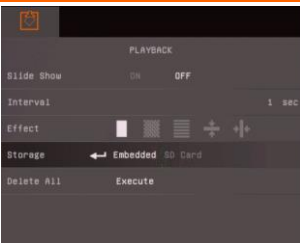

### Current Storage

Select the source of the images.

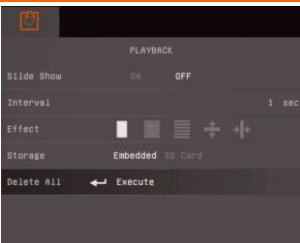

### Delete All

Permanently delete all the data in selected memory source. A Warning Message will appear. Select YES to continue and NO to stop formatting the storage.

# Transfer Captured Images/Videos to a computer

This enables you to transfer the captured image from the built-in memory or SD to a computer.



The instruction below **MUST** be read and followed **BEFORE** connecting the USB cable.

1. **MUST** set the USB to PC as STORAGE before connecting the USB cable.

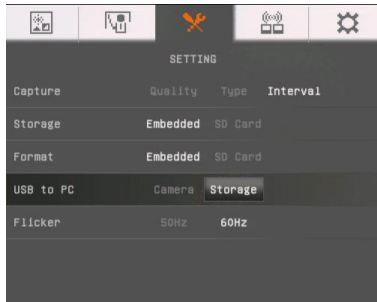

2. When “**Mass Storage Start...**” appears at the lower right corner of the presentation screen, you may now connect the USB cable.
3. Upon connecting the USB cable, the system automatically detects the new removable disk. You can now transfer the captured image(s) from the **F70W built-in memory** to the computer hard disk.

# Technical Specifications

## Image

|               |   |
|---------------|---|
| Sensor        | 1/2.7" CMOS                               |
| Pixel Count   | 2 megapixels                              |
| Frame Rate    | 30 fps (max.)                             |
| White Balance | Auto / Manual                             |
| Exposure      | Auto / Manual                             |
| Image mode    | Text / Graphics / Microscope              |
| Effect        | Color / B/W / Negative // Rotate / Freeze |
| HDMI Output   | HD 1080p 60Hz; HD 720p 60Hz               |
| Image Capture | 240 Frames(XGA) ; 80 Frames(2M Pixel)     |

## Optics

|               |                 |
|---------------|-----------------|
| Focusing      | Auto / Manual   |
| Shooting Area | 330mm x 250mm   |
| Zooming       | 8X Digital zoom |

## Compatibility

|                   |  |
|-------------------|--|
| Wireless Network  | 802.11a/b/g/n/ac (45 ft effective range)     |
| Dual Band         | 5GHz/ 2.4GHz                                 |
| Wireless Security | Supports WEP, AES, TKIP and AES+TKIP, 802.1x |

## Power

|              |   |
|--------------|---|
| Power Source | DC 12V, 100-240V, 50-60Hz                 |
| Consumption  | 16.8 Watts (lamp off); 18 Watts (lamp on) |

## Lighting

|           |           |
|-----------|-----------|
| Lamp Type | LED light |
|-----------|-----------|

## Input/Output

|              |                    |
|--------------|--------------------|
| HDMI Output  | HDMI               |
| HDMI Input   | HDMI               |
| RS-232       | 1 female connector |
| TV Out       | RCA only           |
| USB          | USB2.0             |
| DC 12V Input | Power Jack         |
| MIC          | Phone Jack         |
| Speaker      | Phone Jack         |

## Dimension

|           |   |
|-----------|---|
| Operating | 380mm*200mm*525mm (+/-2mm include rubber foot)    |
| Folded    | 305mm x 230mm x 73mm (+/-2mm include rubber foot) |
| Weight    | 2.65 kg (about 5.84lbs)                           |

## External Storage

|                       |                    |
|-----------------------|--------------------|
| Secure Digital (SDHC) | 1GB ~ 32GB (FAT32) |
|-----------------------|--------------------|

# Using the RS-232 Interface

AVerVision F70W can be controlled using a computer or any centralized control panel through RS-232 connection. The command code for RS-232 is provided for the system integrator to be able to incorporate it with the system program.

## Connect to the Computer RS-232

Locate the RS-232 port of the computer and connect it to RS-232 jack of RS-232 cable.

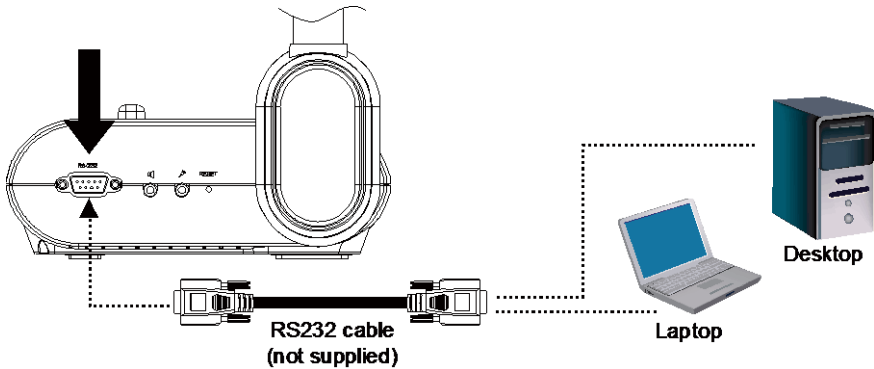

# RS-232 Cable Specifications

Make sure the RS-232 cable matches the cable specification design.

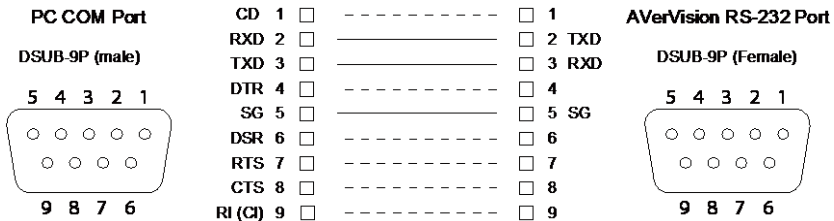

# RS-232 Transmission Specifications

- Start bit : 1 bit
- Data bit : 8 bit
- Stop bit : 1 bit
- Parity bit : None
- X parameter : None
- Baud rate (Communication speed) : 9600bps

## RS-232 Communication Format

|                              |  |  |
|------------------------------|--|--|
| Send Device Code(1 Byte)     | 0x52   |  |
| Type Code (1 Byte)           | 0x0B   | 0x0A   |
| Data Length Code(1 Byte)     | 0x03   | 0x01   |
| Data[0] Code (1 Byte)        | RS-232 Send Command Table  | RS-232 Get Command Table                                     |
| Data[1] Code (1 Byte)        | RS-232 Send Command Table  | X  |
| Data[2] Code (1 Byte)        | RS-232 Send Command Table  | X  |
| Receive Device Code (1 Byte) | 0x53   |  |
| Checksum Code (1 Byte)       | RS-232 Send Command Table  | RS-232 Get Command Table                                     |
| Format                       | Send Device + Type + Length + Data + Receive Data + CheckSum               | Send Device + Type + Length + Data + Receive Data + CheckSum |
| Example                      | Power On Command:<br>0x52 + 0x0B + 0x03 + 0x01 + 0x01 + 0x00 + 0x53 + 0x5B | Get WB Red Value :<br>0x52 + 0x0A + 0x01+ 0x02+ 0x53 + 0x5A  |

## RS-232 Send Command Table

Send Format : 0x52 + 0x0B + 0x03 + Data[0] + Data[1] + Data[2] + 0x53 + CheckSum\*1

Success Receive Format : 0x53 + 0x00 + 0x02+ \*2 + 0x00 + 0x52 + CheckSum\*4

Abnormal Receive Format : 0x53 + 0x00 + 0x01+ \*3 + 0x52 + CheckSum\*5

\*1 : CheckSum = 0x0B xor 0x03 xor Data[0] xor Data[1] xor Data[2] xor 0x53

\*2 : Receive data ok : 0x0B, Not Command : 0x03

\*3 : ID error: 0x01, CheckSum error: 0x02, Function fail = 0x04

\*4 : CheckSum = 0x00 xor 0x02 xor \*2 xor 0x00 xor 0x52

\*5 : CheckSum = 0x00 xor 0x01 xor \*3 xor 0x52

\*6 : Standby Mode Receive Data = 0x51 + 0xFF + 0x01 + 0x0B + 0x51 + 0xA4

Power On Mode Receive Data = No Data Return

\*7 : Standby Mode Receive Data = 0x51 + 0x00 + 0x01 + 0x0B + 0x51 + 0x5B

Power On Mode Receive Data = 0x53 + 0x00 + 0x02 + 0x0B + 0x00 + 0x52 + 0x5B

| Function                       | Data[0] | Data[1] | Data[2]             | CheckSum |
|--------------------------------|---------|---------|---------------------|----------|
| POWER OFF*6                    | 0x01    | 0x00    | 0x00                | 0x5a     |
| POWER ON *7                    | 0x01    | 0x01    | 0x00                | 0x5b     |
| CAMERA MODE                    | 0x02    | 0x00    | 0x00                | 0x59     |
| PLAYBACK MODE                  | 0x03    | 0x00    | 0x00                | 0x58     |
| PC-1 PASS THROUGH              | 0x04    | 0x00    | 0x00                | 0x5f     |
| IMAGE CAPTURE TYPE: SINGLE     | 0x05    | 0x00    | 0x00                | 0x5e     |
| IMAGE CAPTURE TYPE: CONTINUOUS | 0x05    | 0x01    | 0x00                | 0x5f     |
| CONT. CAPTURE INTERVAL +       | 0x06    | 0x00    | 0x00                | 0x5d     |
| CONT. CAPTURE INTERVAL -       | 0x06    | 0x01    | 0x00                | 0x5c     |
| TIMER START                    | 0x08    | 0x00    | 0x00                | 0x53     |
| TIMER PAUSE                    | 0x08    | 0x01    | 0x00                | 0x52     |
| TIMER STOP                     | 0x08    | 0x02    | 0x00                | 0x51     |
| TIMER SET TIME                 | 0x08    | 0x03    | Value[ 1 ~<br>120 ] | *1       |
| PREVIEW MODE: TEXT             | 0x0A    | 0x00    | 0x00                | 0x51     |
| PREVIEW MODE: GRAPHIC          | 0x0A    | 0x01    | 0x00                | 0x50     |
| PREVIEW MODE: MICROSCOPE       | 0x0A    | 0x03    | 0x00                | 0x52     |
| PREVIEW MODE CAPTURE           | 0x0B    | 0x00    | 0x00                | 0x50     |

| Function                    | Data[0] | Data[1] | Data[2]         | CheckSum |
|-----------------------------|---------|---------|-----------------|----------|
| PLAYBACK DELETE             | 0x0C    | 0x00    | 0x00            | 0x57     |
| PLAYBACK FULL SCREEN        | 0x0D    | 0x00    | 0x00            | 0x56     |
| MIRROR OFF                  | 0x0E    | 0x00    | 0x00            | 0x55     |
| MIRROR ON                   | 0x0E    | 0x01    | 0x00            | 0x54     |
| ROTATE 0                    | 0x0F    | 0x00    | 0x00            | 0x54     |
| ROTATE 180                  | 0x0F    | 0x02    | 0x00            | 0x56     |
| EFFECT: COLOR               | 0x10    | 0x00    | 0x00            | 0x4b     |
| EFFECT: B/W                 | 0x10    | 0x01    | 0x00            | 0x4a     |
| EFFECT: NEGATIVE            | 0x10    | 0x02    | 0x00            | 0x49     |
| CONTRAST INCREASE           | 0x11    | 0x00    | 0x00            | 0x4a     |
| CONTRAST DECREASE           | 0x11    | 0x01    | 0x00            | 0x4b     |
| CONTRAST VALUE              | 0x11    | 0x02    | Value[ 1 ~ 32 ] | *1       |
| BRIGHTNESS INCREASE         | 0x12    | 0x00    | 0x00            | 0x49     |
| BRIGHTNESS DECREASE         | 0x12    | 0x01    | 0x00            | 0x48     |
| BRIGHTNESS VALUE            | 0x12    | 0x02    | Value[ 1 ~ 64 ] | *1       |
| EXPOSURE: AUTO              | 0x13    | 0x00    | 0x00            | 0x48     |
| EXPOSURE: MANUAL            | 0x13    | 0x01    | 0x00            | 0x49     |
| EXPOSURE MANUAL INCREASE    | 0x14    | 0x00    | 0x00            | 0x4f     |
| EXPOSURE MANUAL DECREASE    | 0x14    | 0x01    | 0x00            | 0x4e     |
| WHITE BALANCE: AUTO         | 0x15    | 0x00    | 0x00            | 0x4e     |
| WHITE BALANCE: MANUAL       | 0x15    | 0x01    | 0x00            | 0x4f     |
| WHITE BALANCE BLUE INCREASE | 0x16    | 0x00    | 0x00            | 0x4d     |
| WHITE BALANCE BLUE DECREASE | 0x16    | 0x01    | 0x00            | 0x4c     |
| WHITE BALANCE RED INCREASE  | 0x17    | 0x00    | 0x00            | 0x4c     |
| WHITE BALANCE RED DECREASE  | 0x17    | 0x01    | 0x00            | 0x4d     |
| FLICKER: 50Hz               | 0x18    | 0x00    | 0x00            | 0x43     |
| FLICKER: 60Hz               | 0x18    | 0x01    | 0x00            | 0x42     |
| SPOTLIGHT: OFF              | 0x19    | 0x00    | 0x00            | 0x42     |
| SPOTLIGHT: ON               | 0x19    | 0x01    | 0x00            | 0x43     |

| Function                      | Data[0] | Data[1] | Data[2] | CheckSum |
|-------------------------------|---------|---------|---------|----------|
| SPOTLIGHT SHADE: 0% dark      | 0x1A    | 0x00    | 0x00    | 0x41     |
| SPOTLIGHT SHADE: 50% dark     | 0x1A    | 0x01    | 0x00    | 0x40     |
| SPOTLIGHT SHADE: 100% dark    | 0x1A    | 0x02    | 0x00    | 0x43     |
| SPOTLIGHT COLOR: RED          | 0x1B    | 0x00    | 0x00    | 0x40     |
| SPOTLIGHT COLOR: GREEN        | 0x1B    | 0x01    | 0x00    | 0x41     |
| SPOTLIGHT COLOR: BLUE         | 0x1B    | 0x02    | 0x00    | 0x42     |
| SPOTLIGHT RESIZE              | 0x1C    | 0x00    | 0x00    | 0x47     |
| VISOR: OFF                    | 0x1D    | 0x00    | 0x00    | 0x46     |
| VISOR: ON                     | 0x1D    | 0x01    | 0x00    | 0x47     |
| VISOR SHADE: 50% dark         | 0x1E    | 0x00    | 0x00    | 0x45     |
| VISOR SHADE: 100% dark        | 0x1E    | 0x01    | 0x00    | 0x44     |
| PIP: OFF                      | 0x1F    | 0x00    | 0x00    | 0x44     |
| PIP: ON                       | 0x1F    | 0x01    | 0x00    | 0x45     |
| PIP POSITION: BOTTOM LEFT     | 0x20    | 0x00    | 0x00    | 0x7b     |
| PIP POSITION: TOP LEFT        | 0x20    | 0x01    | 0x00    | 0x7a     |
| PIP POSITION: TOP RIGHT       | 0x20    | 0x02    | 0x00    | 0x79     |
| PIP POSITION: BOTTOM RIGHT    | 0x20    | 0x03    | 0x00    | 0x78     |
| SPLITSCREEN: OFF              | 0x21    | 0x00    | 0x00    | 0x7a     |
| SPLITSCREEN: ON               | 0x21    | 0x01    | 0x00    | 0x7b     |
| SPLITSCREEN DIR: UPPER SCREEN | 0x22    | 0x00    | 0x00    | 0x79     |
| SPLITSCREEN DIR: LOWER SCREEN | 0x22    | 0x01    | 0x00    | 0x78     |
| SPLITSCREEN DIR: LEFT SCREEN  | 0x22    | 0x02    | 0x00    | 0x7b     |
| SPLITSCREEN DIR: RIGHT SCREEN | 0x22    | 0x03    | 0x00    | 0x7a     |
| RECORD: OFF                   | 0x23    | 0x00    | 0x00    | 0x78     |
| RECORD: ON                    | 0x23    | 0x01    | 0x00    | 0x79     |
| MOVIE FAST REWIND             | 0x25    | 0x00    | 0x00    | 0x7e     |
| MOVIE FAST FORWARD            | 0x25    | 0x01    | 0x00    | 0x7f     |
| MOVIE VOL INC                 | 0x26    | 0x00    | 0x00    | 0x7d     |
| MOVIE VOL DEC                 | 0x26    | 0x01    | 0x00    | 0x7c     |
| STORAGE: EMBEDDED             | 0x28    | 0x00    | 0x00    | 0x73     |

| Function                     | Data[0] | Data[1] | Data[2] | CheckSum |
|------------------------------|---------|---------|---------|----------|
| STORAGE: SD CARD             | 0x28    | 0x01    | 0x00    | 0x72     |
| FORMAT: EMBEDDED             | 0x29    | 0x00    | 0x00    | 0x72     |
| FORMAT: SD CARD              | 0x29    | 0x01    | 0x00    | 0x73     |
| OUTPUT RESOLUTION: 1024x768  | 0x2F    | 0x01    | 0x00    | 0x75     |
| OUTPUT RESOLUTION: 1280x720  | 0x2F    | 0x02    | 0x00    | 0x76     |
| OUTPUT RESOLUTION: 1920x1080 | 0x2F    | 0x03    | 0x00    | 0x77     |
| OUTPUT RESOLUTION: 1280x1024 | 0x2F    | 0x04    | 0x00    | 0x70     |
| OUTPUT RESOLUTION: 1600x1200 | 0x2F    | 0x05    | 0x00    | 0x71     |
| OUTPUT RESOLUTION: 1280x800  | 0x2F    | 0x06    | 0x00    | 0x72     |
| USB CONNECT: USB CAMERA      | 0x30    | 0x00    | 0x00    | 0x6b     |
| USB CONNECT: MASS STORAGE    | 0x30    | 0x01    | 0x00    | 0x6a     |
| BACKUP TO SD CARD            | 0x31    | 0x00    | 0x00    | 0x6a     |
| PROFILE SAVE: PROFILE 1      | 0x32    | 0x00    | 0x00    | 0x69     |
| PROFILE SAVE: PROFILE 2      | 0x32    | 0x01    | 0x00    | 0x68     |
| PROFILE SAVE: PROFILE 3      | 0x32    | 0x02    | 0x00    | 0x6b     |
| PROFILE RECALL: PROFILE 1    | 0x33    | 0x00    | 0x00    | 0x68     |
| PROFILE RECALL: PROFILE 2    | 0x33    | 0x01    | 0x00    | 0x69     |
| PROFILE RECALL: PROFILE 3    | 0x33    | 0x02    | 0x00    | 0x6a     |
| SLIDESHOW: OFF               | 0x34    | 0x00    | 0x00    | 0x6f     |
| SLIDESHOW: ON                | 0x34    | 0x01    | 0x00    | 0x6e     |
| SLIDESHOW EFFECT: EFFECT 0   | 0x35    | 0x00    | 0x00    | 0x6e     |
| SLIDESHOW EFFECT: EFFECT 1   | 0x35    | 0x01    | 0x00    | 0x6f     |
| SLIDESHOW EFFECT: EFFECT 2   | 0x35    | 0x02    | 0x00    | 0x6c     |
| SLIDESHOW EFFECT: EFFECT 3   | 0x35    | 0x03    | 0x00    | 0x6d     |
| SLIDESHOW EFFECT: EFFECT 4   | 0x35    | 0x04    | 0x00    | 0x6a     |
| AUTO IMAGE:OFF               | 0x36    | 0x00    | 0x00    | 0x6d     |
| AUTO IMAGE:ON                | 0x36    | 0x01    | 0x00    | 0x6c     |
| CAPTURE QUALITY: NORMAL      | 0x37    | 0x00    | 0x00    | 0x6c     |
| CAPTURE QUALITY: HIGH        | 0x37    | 0x01    | 0x00    | 0x6d     |
| CAPTURE QUALITY: FINEST      | 0x37    | 0x02    | 0x00    | 0x6e     |

| Function      | Data[0] | Data[1] | Data[2] | CheckSum |
|---------------|---------|---------|---------|----------|
| AUTO FOCUS    | 0x40    | 0x00    | 0x00    | 0x1b     |
| MENU          | 0x41    | 0x00    | 0x00    | 0x1a     |
| ARROW - DOWN  | 0x42    | 0x00    | 0x00    | 0x19     |
| ARROW - UP    | 0x42    | 0x01    | 0x00    | 0x18     |
| ARROW - LEFT  | 0x42    | 0x02    | 0x00    | 0x1b     |
| ARROW - RIGHT | 0x42    | 0x03    | 0x00    | 0x1a     |
| ENTER         | 0x43    | 0x00    | 0x00    | 0x18     |
| FREEZE        | 0x44    | 0x00    | 0x00    | 0x1f     |
| DEFAULT       | 0x45    | 0x00    | 0x00    | 0x1e     |
| ZOOM -        | 0x46    | 0x00    | 0x00    | 0x1d     |
| ZOOM +        | 0x46    | 0x01    | 0x00    | 0x1c     |
| ZOOM RESET    | 0x47    | 0x00    | 0x00    | 0x1c     |
| NEAR          | 0x48    | 0x00    | 0x00    | 0x13     |
| FAR           | 0x48    | 0x01    | 0x00    | 0x12     |
| LAMP OFF      | 0x49    | 0x00    | 0x00    | 0x12     |
| LAMP ON       | 0x49    | 0x01    | 0x00    | 0x13     |

## RS-232 Get Command Table

Send Format : 0x52 + 0x0A + 0x01 + Data[0] + 0x53 + CheckSum

Receive Format : 0x53 + 0x0C + 0x01 + ReData[0] + 0x52 + ReCheckSum\*1

\*1 : ReCheckSum = 0x0C xor 0x01 xor ReData[0] xor 0x52

\*2 : Power Status Receive Data = 0x51 + 0xFF + 0x01 + 0x0A + 0x51 + 0xA5

| Function            | Data[0] | CheckSum | ReData[0]  |
|---------------------|---------|----------|--|
| Red Value           | 0x02    | 0x5A     | Value[ 0 ~ 255 ]   |
| Blue Value          | 0x03    | 0x5B     | Value[ 0 ~ 255 ]   |
| Power Status        | 0x04    | 0x5C     | OFF [*2]<br>1: ON  |
| Lamp Status         | 0x05    | 0x5D     | 0 : OFF 1: ON  |
| Display Status      | 0x06    | 0x5E     | 0: CAMERA MODE<br>1: PLAYBACK MODE<br>2: PC-1 PASS THROUGH |
| Video Output Status | 0x07    | 0x5F     | 0: HDMI 1: TV  |
| Freeze Status       | 0x08    | 0x50     | 0 : OFF 1: ON  |
| Brightness Value    | 0x0A    | 0x52     | Value[ 1 ~ 64 ]  |
| Contrast Value      | 0x0B    | 0x53     | Value[ 1 ~ 32 ]  |

# Troubleshooting

This section provides many useful tips on how to solve common problems while using the AVerVision F70W.

## General

**I have set up the AVerVision F70W and checked all the connections as specified in the manual but I cannot get a picture on the preferred presentation screen.**

1. Once the power is connected the unit is set to standby mode. Press the POWER button to turn on.
2. If your display output device is on TV or any analog device, please switch the TV-RGB dip switch to TV.

**The picture on the presentation screen is distorted or the image is blurry.**

1. Reset all changed settings, if any, to the original manufacturer default setting. Press MENU then go to SYSTEM > Default and select YES in the OSD menu.
2. Use the Brightness and Contrast menu functions to reduce the distortion if applicable.
3. If you discover that the image is blurry or out of focus, press the Auto Focus button on the control panel or remote control.

**There is no computer signal on presentation screen.**

1. Check all the cable connections among the display device, AVerVision F70W and your PC.
2. Connect your PC to the AVerVision F70W first before you power on your computer.
3. For notebook, repeatedly press FN+F5 to toggles between display modes and display the computer image on the presentation screen. For different command, please refer to your laptop manual.

**The presentation screen does not show the exact desktop image on my PC or Notebook after I toggle from Camera to PC mode.**

1. Return to your PC or Notebook, place the mouse on the desktop and right click, choose "Properties", choose "Setting" tab, click on "2" monitor and check the box "Extend my Windows desktop onto this monitor".
2. Then go back one more time to your PC or Notebook and place the mouse on the desktop and right click again.
3. This time choose "Graphics Options", then "Output To", then "Intel® Dual Display Clone", and then choose "Monitor + Notebook".
4. After you follow these steps, you should be able to see the same desktop image on your PC or Notebook as well as on the presentation screen.

## Advance

### The F70W Wi-Fi connection shows “None” on the OSD menu.

Press “Menu”, go to the Wi-Fi setting page to connect and select “Rescan” to have the system re-scan the airwaves again.

### There’s still no SSID detected on the F70W after re-scanning.

Please check the WiFi Dongle and make sure it is properly inserted into the F70W. Make sure when the system is started, the dongle emits a blue light. Otherwise please check the WiFi Router to make sure it is running. You may have to check with your local system administrator to determine the nature of the problem and call AVer tech support.

### The F70W is connected to my PC via the USB cable but I still can’t see the live image on Sphere2

Please check the F70W onboard keypad and make sure the WiFi LED“(📶)” is turned off, if it is showing a constant blue color please press“(📶)” to turn it OFF. Then re-open Sphere2 and select the camera from the “Visualizer” icon as indicated in the picture below.



### The F70W is streaming to my iPad and PC but I am experiencing live video that is not smooth (eg. missing frames).

There are a lot of possible variables affecting the WiFi performance.

- Please check and use the 5G bandwidth on your WiFi router if supported. The F70W supports 2.4GHz or 5Ghz and up to the 802.11ac standard.
- If you use the Sphere2 software, go to the “Sphere2” Options -> WirelessCam bit-rate setting and toggle the setting down to perhaps 1.24Mbps (using less bandwidth). You have similar options available on the iPad or Android tablet AVer app.

**Power and Network LED light is steady and I am able to see the IP address on the screen as assigned by my Wi-Fi router but my F70W is not detected by the software.**

1. Make sure your computer/tablet is connected to the same Wi-Fi networks (same SSID) as the F70W. If it not, you may need to use the IP search method to connect to the F70W via the IP address (See #2 below).
2. If it is not convenient to open the access ports. You can still connect to the F70W via the IP address of the F70W. Screen below shows where you would punch in the IP of the F70W.

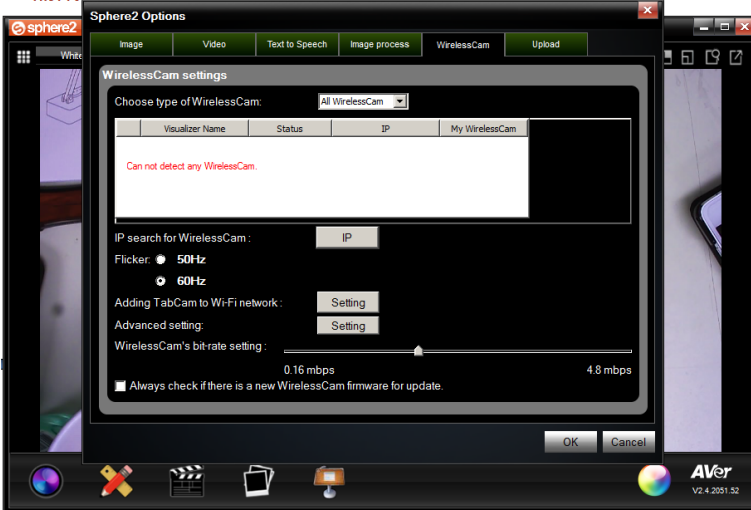

3. Security software (firewall, anti-virus) installed on your computer may be blocking communication between the F70W and computer/tablet. Your Wi-Fi router also may be blocking some TCP/UDP ports. When these ports are blocked, F70W cannot access the Wi-Fi. Please check with your local MIS to unblock. Below is a list of ports to look out for.

| TCP/UDP | Port |
|---------|------|
| UDP     | 1900 |
| TCP     | 9527 |
| TCP     | 9528 |
| TCP     | 8557 |

## I've done everything listed and my F70W still does not connect.

**Solution:** Test your Wi-Fi with our Wi-Fi tool to check compatibility. Please follow these steps:

1. Connect two wireless devices (PC, iPad, or Android) to the same Wi-Fi network.
2. Install WiFi Test Tool by AVer Information Inc. on both devices:
  - a. For PC: Download the WiFi Test Tool [here](#)
  - b. For iPad: Download the WiFi Test Tool by AVer Information Inc. in the App Store (search AVer)
  - c. For Android: Download the WiFi Test Tool by AVer Information Inc. in the Google Play Store (search AVer)
3. Run the WiFi Test Tool on both devices and enter the Remote Device IP of the other device (this is the devices IPv4 address)
4. Press Start on both devices to begin the test
5. If the test passes, your Wi-Fi is compatible with the F70W and should have no problems connecting. If the test fails, you may have to change some settings in your router for the F70W to connect.
6. Please call our tech support and let us know the error log that is generated from the WiFi Test Tool in order for us to help you troubleshoot the problem.

Please refer to this demonstration of the WiFi Test Tool if you need help running the test.

<http://youtu.be/v7WjHAFgWfc>

## I can see my F70W in the list but I cannot see the live view when I select the F70W.

There may be some signal strength issues with the Wi-Fi connection. Please go through the following steps:

1. If your WiFi supports 5GHz radio, please connect to the 5GHz instead of the more crowded 2.4GHz.
2. There may be other devices using your Wi-Fi network at the same time. Bandwidth usage, packet loss and other connection elements may cause the poor video quality.
3. If you are connected via the Sphere2 PC/MAC software, reduce the bandwidth usage by toggling the bandwidth setting. (eg. Sphere2 -> Options -> WirelessCam -> WirelessCam bitrate Settings)

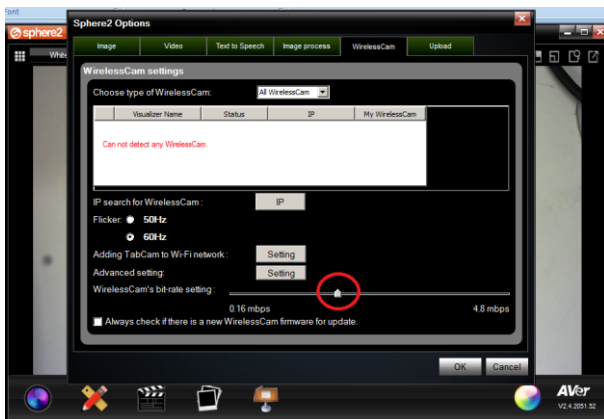

# Limited Warranty

For a period of time beginning on the date of purchase of the applicable product and extending as set forth in the **“Warranty Period of AVer Product Purchased”** section of the warranty card, AVer Information, Inc. (“AVer”) warrants that the applicable product (“Product”) substantially conforms to AVer’s documentation for the product and that its manufacture and components are free of defects in material and workmanship under normal use. “You” as used in this agreement means you individually or the business entity on whose behalf you use or install the product, as applicable. This limited warranty extends only to You as the original purchaser. Except for the foregoing, the Product is provided “AS IS.” In no event does AVer warrant that You will be able to operate the Product without problems or interruptions, or that the Product is suitable for your purposes. Your exclusive remedy and the entire liability of AVer under this paragraph shall be, at AVer’s option, the repair or replacement of the Product with the same or a comparable product. This warranty does not apply to (a) any Product on which the serial number has been defaced, modified, or removed, or (b) cartons, cases, batteries, cabinets, tapes, or accessories used with this product. This warranty does not apply to any Product that has suffered damage, deterioration or malfunction due to (a) accident, abuse, misuse, neglect, fire, water, lightning, or other acts of nature, commercial or industrial use, unauthorized product modification or failure to follow instructions included with the Product, (b) misapplication of service by someone other than the manufacturer’s representative, (c) any shipment damages (such claims must be made with the carrier), or (d) any other causes that do not relate to a Product defect. The Warranty Period of any repaired or replaced Product shall be the longer of (a) the original Warranty Period or (b) thirty (30) days from the date of delivery of the repaired or replaced product.

## Limitations of Warranty

AVer makes no warranties to any third party. You are responsible for all claims, damages, settlements, expenses, and attorneys’ fees with respect to claims made against You as a result of Your use or misuse of the Product. This warranty applies only if the Product is installed, operated, maintained, and used in accordance with AVer specifications. Specifically, the warranties do not extend to any failure caused by (i) accident, unusual physical, electrical, or electromagnetic stress, neglect or misuse, (ii) fluctuations in electrical power beyond AVer specifications, (iii) use of the Product with any accessories or options not furnished by AVer or its authorized agents, or (iv) installation, alteration, or repair of the Product by anyone other than AVer or its authorized agents.

## Disclaimer of Warranty

EXCEPT AS EXPRESSLY PROVIDED OTHERWISE HEREIN AND TO THE MAXIMUM EXTENT PERMITTED BY APPLICABLE LAW, AVER DISCLAIMS ALL OTHER WARRANTIES WITH RESPECT TO THE PRODUCT, WHETHER EXPRESS, IMPLIED, STATUTORY OR OTHERWISE, INCLUDING WITHOUT LIMITATION, SATISFACTORY QUALITY, COURSE OF DEALING, TRADE USAGE OR PRACTICE OR THE IMPLIED WARRANTIES OF MERCHANTABILITY, FITNESS FOR A PARTICULAR PURPOSE OR NONINFRINGEMENT OF THIRD PARTY RIGHTS.

## Limitation of Liability

IN NO EVENT SHALL AVER BE LIABLE FOR INDIRECT, INCIDENTAL, SPECIAL, EXEMPLARY, PUNITIVE, OR CONSEQUENTIAL DAMAGES OF ANY NATURE INCLUDING, BUT NOT LIMITED TO, LOSS OF PROFITS, DATA, REVENUE, PRODUCTION, OR USE, BUSINESS INTERRUPTION, OR PROCUREMENT OF SUBSTITUTE GOODS OR SERVICES ARISING OUT OF OR IN CONNECTION WITH THIS LIMITED WARRANTY, OR THE USE OR PERFORMANCE OF ANY PRODUCT, WHETHER BASED ON CONTRACT OR TORT, INCLUDING NEGLIGENCE, OR ANY OTHER LEGAL THEORY, EVEN IF AVER HAS ADVISED OF THE POSSIBILITY OF SUCH DAMAGES. AVER’S TOTAL, AGGREGATE LIABILITY FOR DAMAGES OF ANY NATURE, REGARDLESS OF FORM OF ACTION, SHALL IN NO EVENT EXCEED THE AMOUNT PAID BY YOU TO AVER FOR THE SPECIFIC PRODUCT UPON WHICH LIABILITY IS BASED.

## Governing Law and Your Rights

This warranty gives you specific legal rights; You may also have other rights granted under state law. These rights vary from state to state.



For warranty period, please refer to the warranty card.

---

---