

Federal Communications Commission Statement(Class A)



NOTE- This equipment has been tested and found to comply with the limits for a Class A digital device, pursuant to Part 15 of the FCC Rules. These limits are designed to provide reasonable protection against harmful interference in a residential installation. This equipment generates uses and can radiate radio frequency energy and, if not installed and used in accordance with the instructions, may cause harmful interference to radio communications. However, there is no guarantee that interference will not occur in a particular installation. If this equipment does cause harmful interference to radio or television reception, which can be determined by tuning the equipment off and on, the user is encouraged to try to correct the interference by one or more of the following measures:

- Reorient or relocate the receiving antenna.
- Increase the separation between the equipment and receiver.
- Connect the equipment into an outlet on a circuit different from that to which the receiver is connected.
- Consult the dealer or an experienced radio/television technician for help.

Class A ITE:

Class A ITE is a category of all other ITE which satisfies the class A ITE limits but not the class B ITE limits. Such equipment should not be restricted in its sale but the following warning shall be included in the instructions for use:

Warning - This is a class A product. In a domestic environment this product may cause radio interference in which case the user may be required to take adequate measures.

CE Class A (EMC)



This product is herewith confirmed to comply with the requirements set out in the Council Directives on the Approximation of the laws of the Member States relating to Electromagnetic Compatibility Directive 2004/108/EEC.

Warning - This is a Class A product. In a domestic environment this product may cause radio interference in which case the user may be required to take adequate measures to correct this interference.

DISCLAIMER

No warranty or representation, either expressed or implied, is made with respect to the contents of this documentation, its quality, performance, merchantability, or fitness for a particular purpose. Information presented in this documentation has been carefully checked for reliability; however, no responsibility is assumed for inaccuracies. The information contained in this documentation is subject to change without notice.

In no event will AVer be liable for direct, indirect, special, incidental, or consequential damages arising out of the use or inability to use this product or documentation, even if advised of the possibility of such damages.

TRADEMARKS

AVerVision is registered trademarks of AVer Information Inc. IBM PC is a registered trademark of International Business Machines Corporation. Macintosh is a registered trademark of Apple Computer, Inc. Microsoft is a registered trademark and Windows is a trademark of Microsoft Corporation. All other products or corporate names mentioned in this documentation are for identification and explanation purposes only, and may be trademarks or registered trademarks of their respective owners.

COPYRIGHT

© 2011 by AVer Information Inc. All rights reserved. No part of this publication may be reproduced, transmitted, transcribed, stored in a retrieval system, or translated into any language in any form by any means without the written permission of AVer Information Inc.



THE MARK OF CROSSED-OUT WHEELED BIN INDICATES THAT THIS PRODUCT MUST NOT BE DISPOSED OF WITH YOUR OTHER HOUSEHOLD WASTE. INSTEAD, YOU NEED TO DISPOSE OF THE WASTE EQUIPMENT BY HANDING IT OVER TO A DESIGNATED COLLECTION POINT FOR THE RECYCLING OF WASTE ELECTRICAL AND ELECTRONIC EQUIPMENT. FOR MORE INFORMATION ABOUT WHERE TO DROP OFF YOUR WASTE EQUIPMENT FOR RECYCLING, PLEASE CONTACT YOUR HOUSEHOLD WASTE DISPOSAL SERVICE OR THE SHOP WHERE YOU PURCHASED THE PRODUCT.

Remote Control Battery Safety Information

- Store batteries in any cool & dry place.
- Do not dispose used batteries in domestic waste. Dispose batteries at special collection points or return to stores if applies.
- Remove the batteries if they are not in use for long period of time. Battery leakage and corrosion can damage the remote control, dispose batteries safely.
- Do not mix and use old and new batteries.
- Do not mix and use different types of batteries: alkaline, standard (carbon-zinc) or rechargeable (nickel-cadmium).
- Do not dispose batteries in a fire.
- Do not attempt to short circuit the battery terminals.

Table of Contents

Package Contents	1
Optional Accessories	1
Get Familiar with the AVerVision F50	2
Right Panel	2
Rear Panel	3
Left Panel	3
Control Panel	4
Remote Control	6
Making the Connections	9
Set the TV-RGB Switch Setting	9
Connect to a Monitor or LCD/DLP Projector	10
Connect to a Monitor or LCD/DLP Projector with DVI-I interface	10
Connect to a TV	11
Connecting the Power	11
Connect to a Computer	12
Connect to a Computer via USB	12
Connect an External Microphone	13
Connect an Amplified Speaker	13
Connect to a Microscope	14
Setting Up AVerVision F50	15
Storing and Handling	15
Shooting Area	15
Overhead Light	16
Infrared Sensor	17
Anti-glare Sheet	17
External Memory Storage	17
Insert an SD Card	17
Insert a USB Flash Drive	18
OSD MENU	19
Navigate the Menu and Submenu	20
Image	20
Brightness	20
Contrast	20
Mode	21
Effect	21
Mirror	21
Advanced	21
Auto Image	22
Exposure	22
White Balance	22
Focus	22
Presentation	23
Spotlight	23

Visor.....	23
PIP.....	24
Split Screen	24
Timer.....	25
Setting	25
Capture.....	25
Resolution.....	25
Quality	25
Type.....	26
Interval.....	26
Recording	26
Storage	26
Format	26
USB to PC	27
Flicker	27
System	27
Language.....	27
Output Display	27
Backup.....	28
Save Setting	28
Recall Setting.....	28
Information.....	28
Default	28
Playback.....	29
Slide Show.....	29
Interval.....	29
Slide Show Effect.....	29
Current Storage	29
Delete All	29
Annotation	30
Connecting a USB mouse	30
Using the Annotation.....	30
Transfer Captured Images/Videos to a computer	31
Technical Specifications	32
Image.....	32
Optics	32
Power	32
Lighting.....	32
Input/Output.....	32
Dimension.....	33
External Storage	33
Using the RS-232 Interface	33
Connect to the Computer RS-232	33
RS-232 Cable Specifications.....	34
RS-232 Transmission Specifications	34
RS-232 Communication Format.....	34
RS-232 Send Command Table.....	34

RS-232 Get Command Table	39
Troubleshooting	40
Limited Warranty	41

Package Contents

Make sure the following items are included in the package.

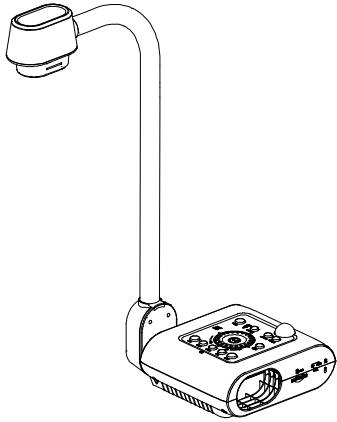

AVerVision F50



RS-232/CVBS Cable

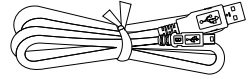

USB Cable

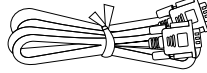

RGB Cable

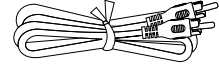

RCA Cable

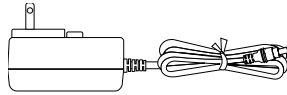

Power Adapter (12V, 2A)

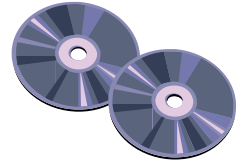

Software & Manual CD

* The power adapter will vary depending on the standard power outlet of the country where it is sold.

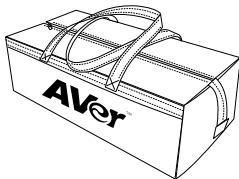

Carrying Bag



Remote Control
(batteries included)

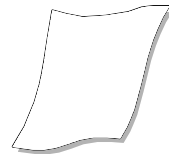

Anti-glare Sheet

Optional Accessories



Microscope Adapter



28mm Rubber
Coupler



34mm Rubber
Coupler

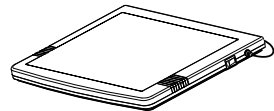

Light Box

Get Familiar with the AVerVision F50

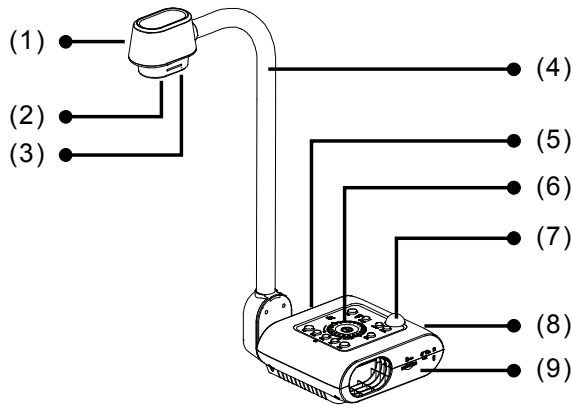

(fig. 1.1)

Name	Function
(1) Camera head	Contain the camera sensor.
(2) Camera lens	Focus the image in the camera.
(3) LED light	Provide light to enhance the lighting condition.
(4) Flexible arm	Provide adjustable viewing coverage.
(5) Left panel	Connections for DVI-I external display device, microphone, speaker, USB flash drive/USB mouse, and USB switch.
(6) Control panel	Easy access to various functions.
(7) IR sensor	Receive remote control commands.
(8) Rear panel	Connections for power, computer, RGB/RCA external display device, RS-232, and USB to PC.
(9) Right panel	Connections for the camera head holder, SD card, TV-RGB display output switch, and antitheft Kensington security lock compatible slot.

Right Panel

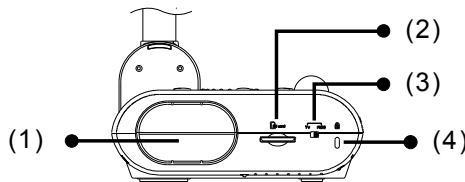

(fig. 1.2)

Name	Function
(1) Camera Holder	Hold the camera head for storage.
(2) SD card slot	Insert the SD card with the label facing up.
(3) TV-RGB switch	TV switch to output display video from RS232/CVBS (via RCA connection), and RGB to RGB OUT and DVI-I OUT ports.
(4) Antitheft Slot	Attach a Kensington compatible security lock or antitheft device.

Rear Panel

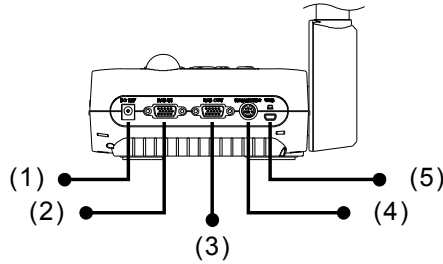



(fig. 1.3)

Name	Function
(1) DC12V	Connect the power adapter into this port.
(2) RGB INPUT port	Input the signal from a computer or other sources and pass it through to the RGB OUT port only. Connect this port to the RGB/VGA output port of a computer.
(3) RGB OUTPUT port	Connect the AVerVision F50 to any display device with RGB cable
(4) RS-232/CVBS port	Connect the supplied RS-232/CVBS cable into this port. The RCA jack outputs the video signal from the camera to a TV or video equipment. The RS-232 jack is used to connect to computer serial port or to any control panel or for centralized control if desire.
(5) Mini USB port	Connect to a USB port of a computer with a USB cable and use AVerVision F50 as a USB camera or transfer the captured images/videos from the memory source to computer.

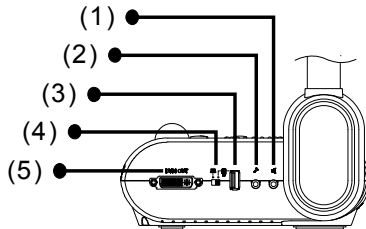
Left Panel



(fig. 1.4)

Name	Function
(1) Speaker port	Connect to an amplified speaker to playback recorded audio & video clip.
(2) MIC port	Connect a 3.5mm plug microphone. The built-in mic will be disabled when an external MIC is connected to this port.
(3) USB port	Insert a USB flash drive save the images/video directly from the USB flash drive or use a USB mouse to annotate.
(4) USB switch	Switch to  for audio video recording directly to a USB flash drive or use a USB mouse to annotate and  when connecting AVerVision F50 to a computer using a USB cable from the rear USB port.

Name	Function
(5) DVI-I OUTPUT port	Connect the AVerVision F50 to any display device with DVI cable. If the display device does not support DVI-I, you can only view in Camera and Playback mode.

Control Panel

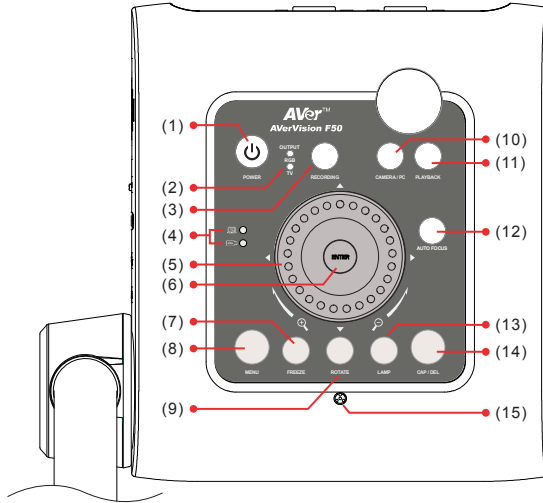

(fig. 1.5)

Name	Function
(1) POWER	Turn the unit on/standby mode.
(2) OUTPUT LED	Indicate TV-RGB switch selection to show which port the video signal is sent out. <ul style="list-style-type: none"> TV indicates that the video signal is sent out thru RS232/CVBS port via RCA connection. RGB indicates the video signal is sent out thru RGB OUT and DVI-I OUT ports.
(3) RECORDING	Start/Stop audio & video recording. Audio and video recording can be saved on a SD card or an USB Flash drive only. See External Memory Storage .
(4) USB Switch LED	Indicate the USB switch selection to show which USB port is activated. <ul style="list-style-type: none"> allowing you to use the AVerVision F50 as USB camera or transfer the captured images/videos from the memory source to computer. allowing you to save the images/video in the USB flash drive or use a USB mouse to annotate.
(5) Shuttle Wheel	<ul style="list-style-type: none"> Turn the shuttle wheel clockwise to zoom in and counter-clockwise to zoom out the image in Camera and Playback mode only. When it reaches the maximum optical zoom level of about 8X, you can still continue to AVERZOOM up to 1.25X and 8X digital zoom. Press the shuttle wheel ▲, ▼, ◀, & ▶ to pan the image while in zoom in mode, to make a selection on 16-thumbnail images or

Name	Function
Shuttle Wheel	<p>move to the next or previous single full screen preview in Playback mode, or to make a selection and adjustment on the OSD main-menu and sub-menu (See Menu Functions for more details).</p> <ul style="list-style-type: none"> - Use ▲ & ▼ to increase and decrease the video playback volume. - Use ◀ & ▶ to play the video backward and forward. - Move the Spotlight frame and Visor screen cover.
(6) 	<ul style="list-style-type: none"> - Make a selection in Playback mode and OSD menu. - Start/Pause video playback.
(7) FREEZE	<ul style="list-style-type: none"> - Pause or resume image display in Camera mode. - Stop audio & video playback in Playback mode.
(8) MENU	Open and exit the OSD menu.
(9) ROTATE	Turn the image by 90° in camera mode only.
(10) CAMERA / PC	Switch the video signal between camera or computer from the RGB IN port.
(11) PLAYBACK	View & playback captured still images and video files.
(12) AUTO FOCUS	Adjust the focus automatically.
(13) LAMP	Turn the overhead light on/off.
(14) CAP/DEL	<ul style="list-style-type: none"> - Capture picture in Camera mode. In continuous capture mode, press this button again to stop. - Delete the selected picture/video in Playback mode.
(15) Built-in MIC	Record audio when recording video clip. The recorded sound will be in monophonic.

Remote Control

The remote control requires two (2) “AAA” size batteries (supplied), make sure batteries are installed properly before use. You can access all the features of AVerVision F50 with the remote.

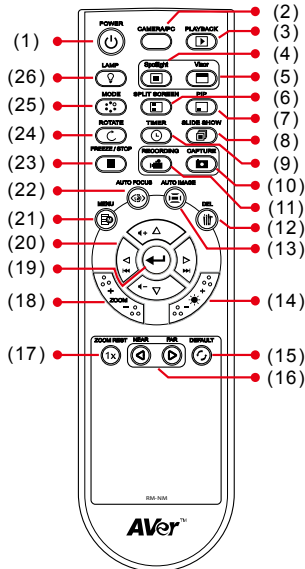

(fig. 1.6)

Name	Function
(1) POWER	Turn the unit on/standby.
(2) CAMERA / PC	Switch between Camera and computer mode. - Camera mode displays the video signal from the built-in camera. - PC mode displays the video signal from the RGB INPUT port of F50.
(3) PLAYBACK	View the captured picture/video from the memory in 16-thumbnail images.
(4) SPOTLIGHT	Call the Spotlight submenu. Spotlight overlays a box frame on the presentation screen. You can adjust the box size and move it around. In the Spotlight submenu, the following options are available.

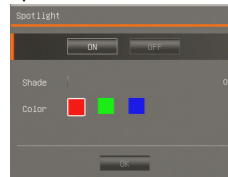

ON/OFF – select to run/cancel the

Spotlight. Press to move to the next selection.

Shade – set the opacity level of the area outside the box. The shaded area will completely turns black when it is set to

level 100. Press to move to the next selection.

Color – select the Spotlight frame color.

Press to move to the next selection.

OK – press for the setting to take effect. If you select ON, the frame will appear and blink, use the , , , & buttons to adjust the frame size and





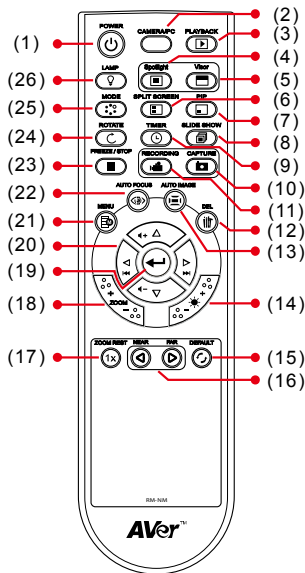

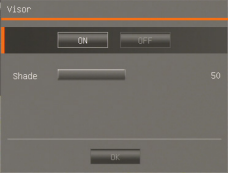

press to set the desired size; and OFF will close the submenu.

To turn off Spotlight, press again.



(fig. 1.6)

Name **Function**

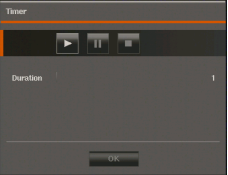
Name	Function
(5) VISOR	<p>Call the Visor submenu. Visor covers part of the presentation screen and allow presenter to reveal the material as desire.</p> <p>In the Visor submenu, the following options are available.</p>  <p>ON/OFF – select to run/cancel the Visor.</p> <p>Press  to move to the next selection.</p> <p>Shade – set the opacity level of the covered area. The shaded area will completely turns black when it is set to level 100. Press  to move to the next selection.</p> <p>OK – press  for the setting to take effect. If you select ON, upper part of the presentation screen is slightly exposed. Use the , , , &  buttons to reveal more of the covered area; and OFF will close the submenu.</p> <p>To turn off Visor, press  again.</p>
(6) SPLIT SCREEN	<p>Divide the screen into two. One side displays the live image from the built-in camera and the other side displays 8-thumbnail size picture/video from the memory.</p>
(7) PIP	<p>Show a thumbnail size captured picture/video from the memory at the corner of the screen in Camera mode.</p>
(8) SLIDE SHOW	<p>Start/Stop automatically showing the captured picture/video one-by-one.</p>
(9) TIMER	<p>Call the Timer submenu. Select to Start/Pause/Stop the timer countdown and set the timer duration.</p> 

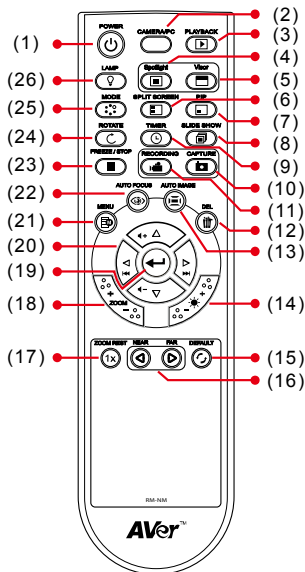

(fig. 1.6)

Name	Function
(10) CAPTURE	Capture still image in Camera mode. In continuous capture mode, press this button again to stop.
(11) RECORDING	Start/Stop audio & video recording. Video recording can only be saved either in a SD memory card or a USB flash drive.
(12) DEL	Delete the selected picture/video in Playback mode.
(13) AUTO IMAGE	Automatically adjust and set the white balance and exposure setting.
(14) BRIGHTNESS +/-	Adjust the brightness.
(15) DEFAULT	Reset at factory default setting.
(16) NEAR / FAR	Adjust the focus manually.
(17) ZOOM RESET	Reset zoom level to 100%.
(18) ZOOM +/-	<ul style="list-style-type: none"> - Increase/decrease the image magnification in camera and picture playback mode. - Use to easily page up and page down 16-thumbnail picture preview.
(19) 	<ul style="list-style-type: none"> - Make a selection in Playback mode and OSD menu. - Play/Pause video playback.
(20) ▲, ▼, ◀, & ▶	<ul style="list-style-type: none"> - Pan the image when image is above 10X zoom in live mode or in playback captured image mode. - Move the selection in Playback mode and in OSD menu. - Use ▲&▼ to increase and decrease the video playback volume. - Use ◀&▶ to play the video backward and forward. - Move the Spotlight frame and Visor screen cover.
(21) MENU	Open and exit the OSD menu.
(22) AUTO FOCUS	Adjust the focus automatically.
(23) FREEZE / STOP	<ul style="list-style-type: none"> - Freeze live images. - Stop video playback.
(24) ROTATE	Rotate the image by 90° in Camera mode and Playback mode.
(25) MODE	Select from 6 type of modes: Sharp - adjust the contrast along the edges making text appear more

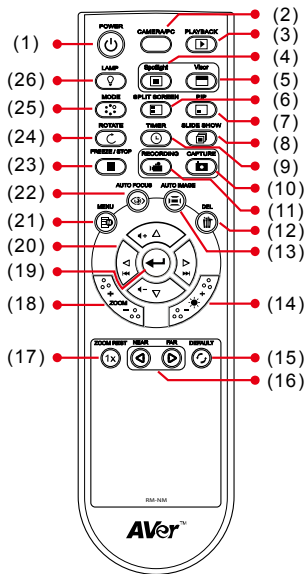

(fig. 1.6)





Name	Function
(25) MODE	visible. Graphics - adjust the gradient of image. Motion - increase frame rate. Sufficient lighting is required when using this mode. Microscope - automatically adjust optical zoom for microscopic viewing. Macro - set to view when object is only 5 – 20 cm away from the camera. Infinite - set to view when subject is at least 55cm away from the camera.
(26) LAMP	Turn the overhead light on/off.

Making the Connections

Before making the connection, make sure the power of all devices are turned off. If you are not sure on where to connect, simply follow the illustrated connections below and also refer to the user manual of the device you are connecting the AVerVision F50 with.

Set the TV-RGB Switch Setting

The TV-RGB switch determines the display output selection. Switch it to RGB (right) to output signal using RGB/DVI-I connection and TV (left) to output signal using RCA connection. (see fig. 1.2 # 3)

Switch	AVerVision Port	Display Device Port
RGB	 RGB OUTPUT DVI-I OUTPUT	 RGB INPUT DVI-I INPUT
	 RS232/ CVBS (use RS-232/ CVBS cable)	 VIDEO IN

To

Connect to a Monitor or LCD/DLP Projector

Locate the RGB (VGA) input port of the graphics display device and connect it to RGB OUT port of AVERVISION F50.



Make sure the TV/RGB switch is set to RGB.

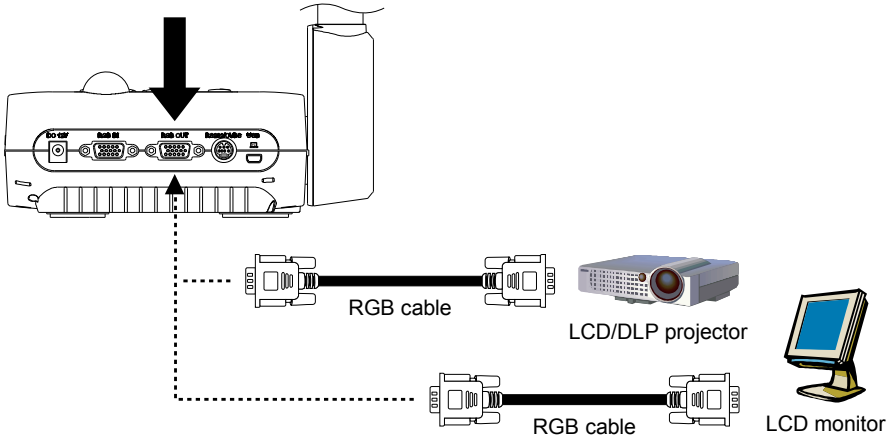

Connect to a Monitor or LCD/DLP Projector with DVI-I interface

Locate the DVI-I input port of the display device and connect it to DVI-I OUT port of AVerVision F50.



Make sure the TV/RGB switch is set to RGB.

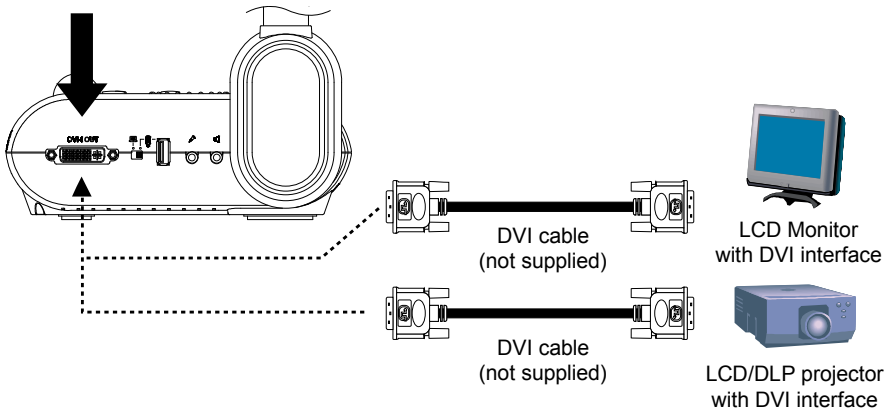

Connect to a TV

Locate the VIDEO or SCART RGB (if applicable) input port of the TV or Video equipment (i.e., VCR) to record your presentation and connect it to RCA jack of RS-232/CVBS cable.

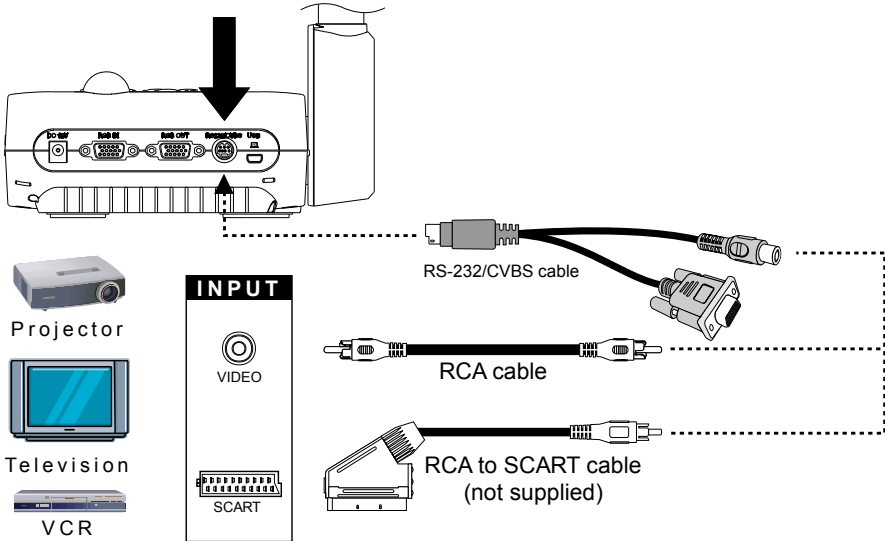

Connecting the Power

Connect the power adapter to a standard 100V~240V AC power outlet. The unit automatically in standby mode once the power is connected. Press  to turn on.

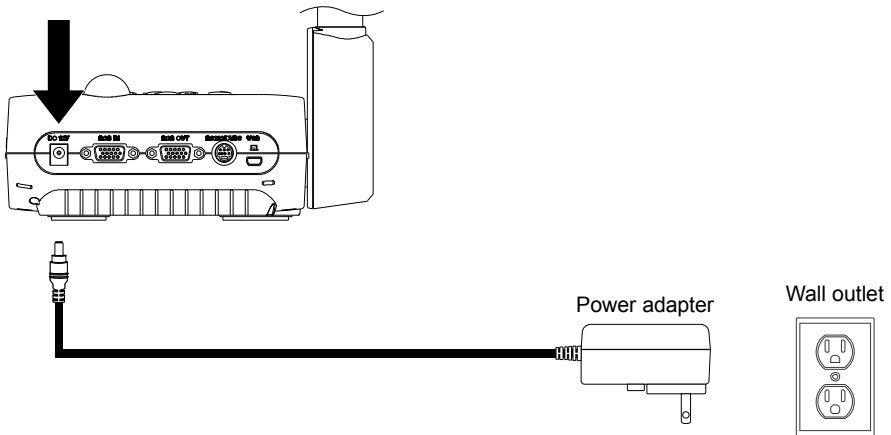

Connect to a Computer



Locate the RGB (VGA) output port of the computer or laptop and connect it to RGB IN port of AVerVision F50. The video signal from the RGB IN port is streamed to RGB OUT and DVI-I OUT port.

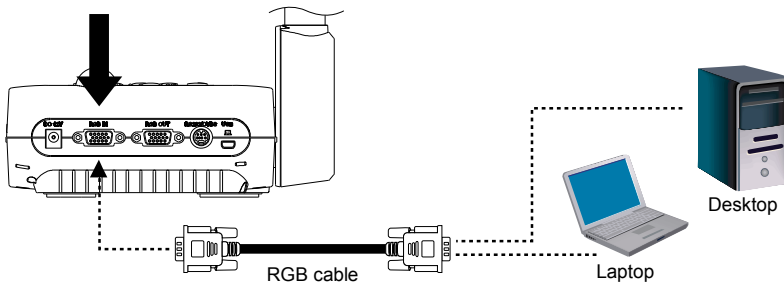

- To display computer image, press Camera/PC button on the control panel or remote control to switch AVerVision F50 to computer mode.
- For laptop to output display image, use the keyboard command (FN+F5) to switch between the display modes. For different command, please refer to your laptop manual.



Connect to a Computer via USB

1. Set the USB switch on the left panel to  and the  LED on the control panel will light up. This enables you to use AVerVision F50 as a USB Camera or to transfer the captured pictures/videos from the memory source and to computer. Also see "Transfer File from AVerVision F50 to PC".

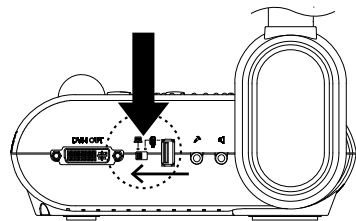

2. Locate the USB port of the computer or laptop and connect it to PC port of AVerVision F50.

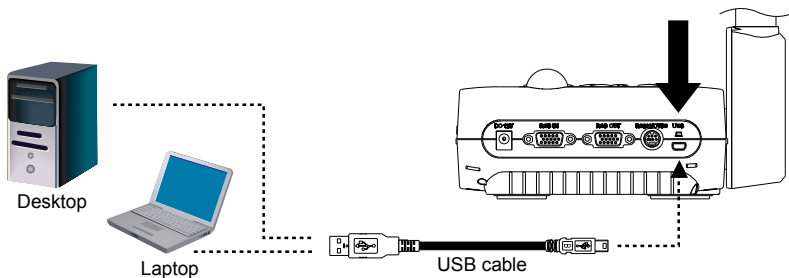

Connect an External Microphone

Plug a 3.5mm mono microphone to  port. The built-in microphone on the control panel will be disabled when an external microphone is connected. The recorded audio will be in monophonic sound.

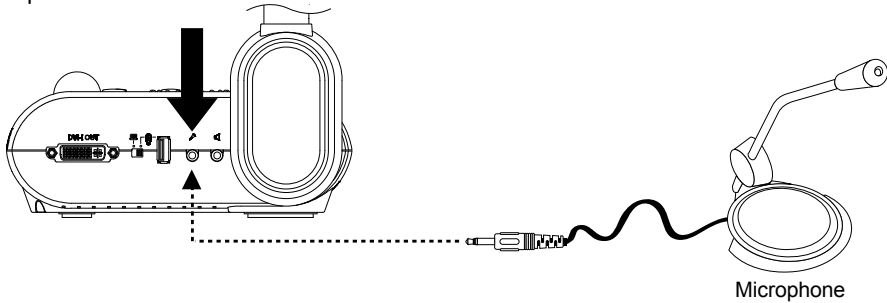

Connect an Amplified Speaker

Plug a 3.5mm plug amplified speaker to  port. Only the audio from the video playback is supported.



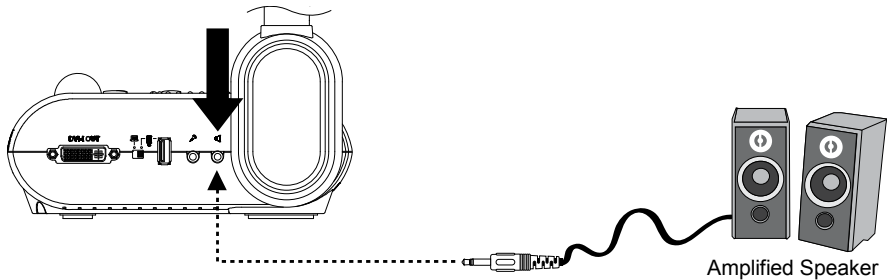

We recommend connecting an amplified speaker to the Audio output port. Take caution when using earphones. Adjust the volume down on the remote to prevent hearing damage due to loudness.



Connect to a Microscope

Connect the AVerVision F50 to a microscope enables you to examine microscopic objects on a big screen.

1. Change the image display mode to Microscope. Press **MENU** > select **IMAGE** tab > select **MODE** > select  **(microscope)** and press .

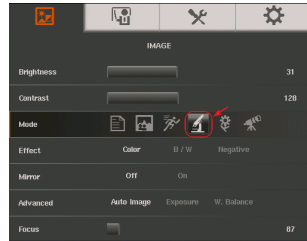

2. Aim the camera head at the farthest point and press **AUTO FOCUS**.
3. Adjust the focus of the microscope.



4. Select the appropriate rubber coupler size for the microscope eyepiece and insert it in the microscope adapter.
5. Remove the microscope eyepiece from the microscope and connect it to the microscope adapter with the rubber coupler inserted. Fasten the 3 bolts until the adapter secures the eyepiece.

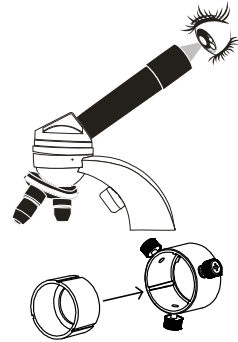

 For the eyepiece, we suggest using 15.5mm eye relief or higher.

6. Attach the microscope adapter to the AVerVision camera head. Then connect it to the AVerVision and microscope.

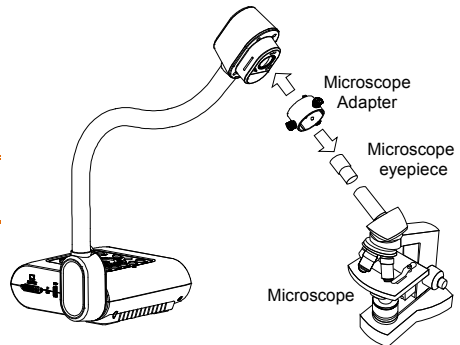

Make sure the arrow on the camera head and microscope adapter are on the same side to connect and twist clockwise for the arrows to meet and lock.

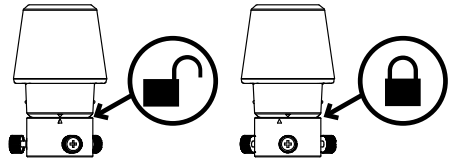

Setting Up AVerVision F50

This section provides useful tips on how to adjust the AVerVision F50 to meet your needs.

Storing and Handling

The gooseneck design allows you to freely bend the arm and store the camera head in the camera holder. Once you have properly secured the camera head to the camera holder, you may use the arm to carry AVerVision F50.

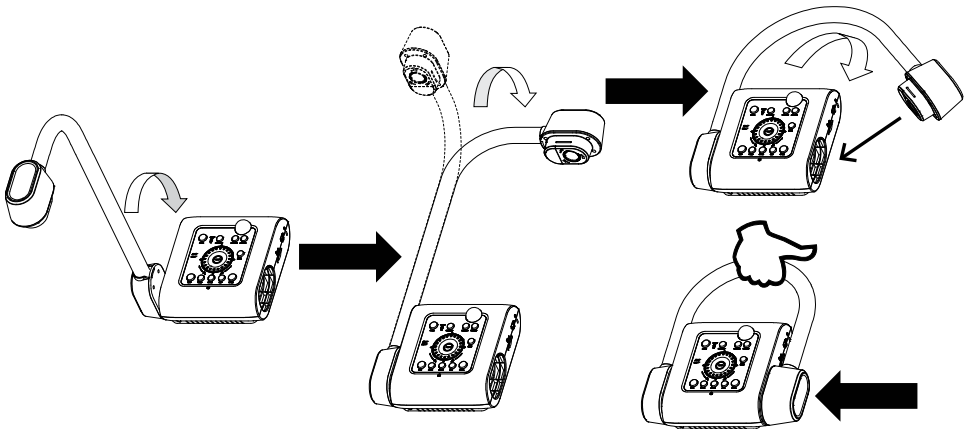

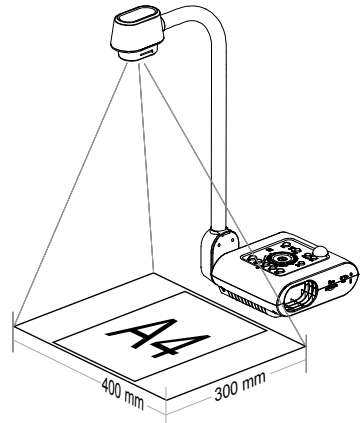

Shooting Area

The shooting area can view an area of 400x300mm which allows you to show an A4 size portrait paper.

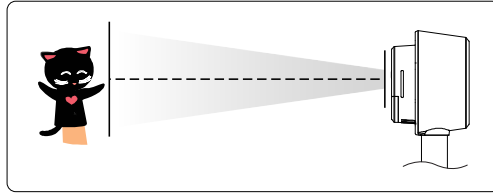

If the camera head is in upright position, press ROTATE on the control panel or remote control twice to rotate the image in 180°.



To mirror the image, press MENU > select Mirror, press , and select On.



Overhead Light

Press LAMP button on the control panel or remote control to turn on and off light.

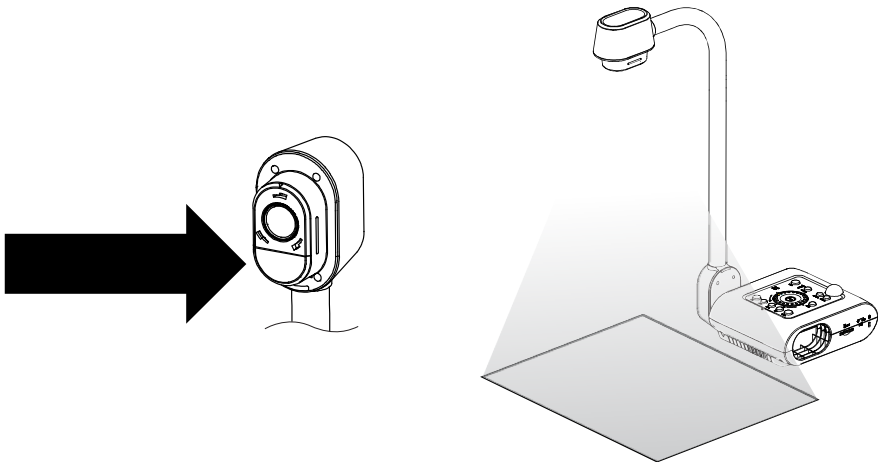

Infrared Sensor

Aim the remote control at the infrared sensor to operate the unit.

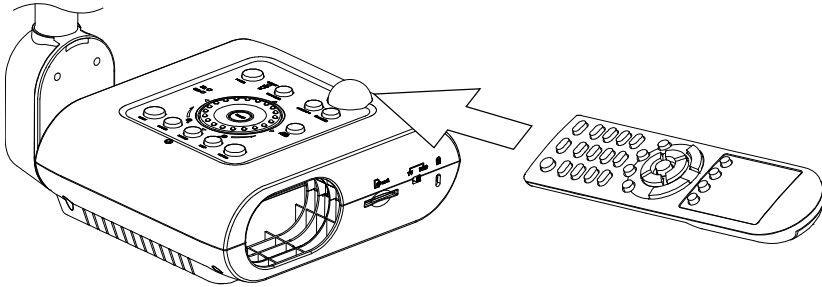

Anti-glare Sheet

The anti-glare sheet is a special coated film that helps eliminate any glare that maybe encountered while displaying very shiny objects or glossy surfaces such as magazines and pictures. To use, simply place the anti-glare sheet on top of the shiny document to reduce reflected light.

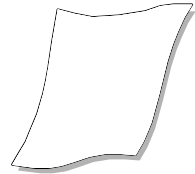

External Memory Storage

AVerVision F50 supports both SD memory card and USB flash drive for more image capture and audio & video recordings. AVerVision F50 can detect when there is an external storage media and automatically switch to the last detected storage. If no external storage is connected, all captured still images will be saved in the built-in memory.

Insert an SD Card



Insert the card with the contact facing down until it reaches the end. To remove the card, push to eject and pull the card out. The supported SD card capacity is from 1GB to 32GB (FAT32). We recommend using SDHC card with class-6 or above for high quality recording.

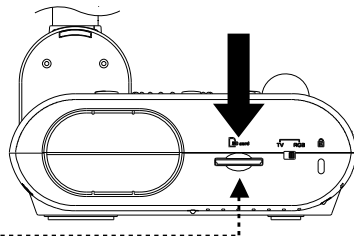

SD Card



Insert a USB Flash Drive

1. Set the USB switch on the left panel to . AVerVision F50 will then detect the USB flash drive and the  LED on the control panel will light up.

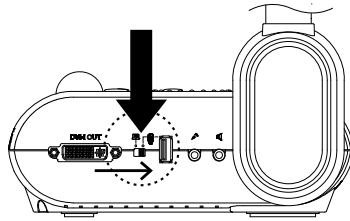

2. Connect the USB flash drive in the USB slot. AVerVision F50 can support USB flash drive from 2GB to 64GB (FAT32). **Best to format the USB flash drive using AVerVision F50 for better video recording.**



USB Flash Drive

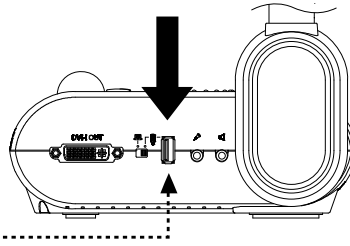

OSD MENU

There are 4 tabs on the OSD menu: IMAGE, PRESENTATION, SETTING and SYSTEM. In Playback mode, you can access PLAYBACK OSD menu to enable the Slide Show feature and modify Slide Show interval and transition setting if desire.



For TV output, the RESOLUTION will be disabled in SETTING menu list.

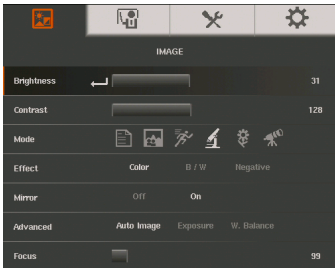

IMAGE

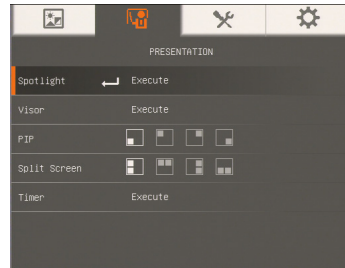

PRESENTATION

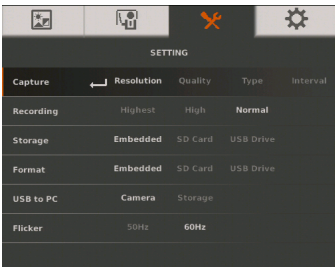

SETTING

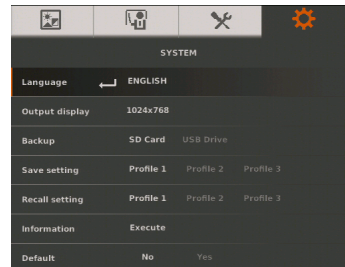

SYSTEM

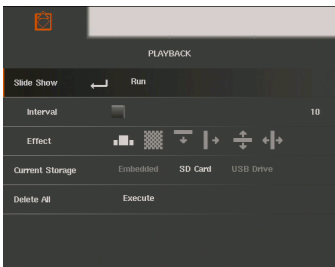

PLAYBACK



ANNOTATION

Navigate the Menu and Submenu

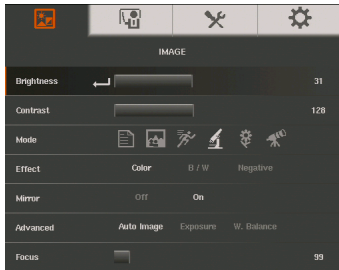

1. Press MENU button on the remote or control panel.
2. Press ► and ◀ to toggle between tabs
3. Press ▼ and ▲ to choose a selection in the menu list.
4. Press ◀ to make a selection.
5. Use ► and ◀ to adjust the setting or make a selection.
6. Press ◀ to enter submenu.
7. Press MENU to close the OSD menu.

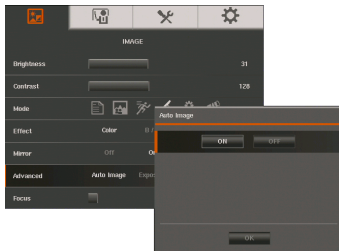

Image

Menu Screen

Function

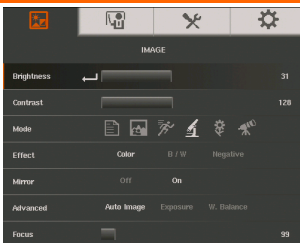

Brightness

Adjust brightness level manually between 0 and 63.

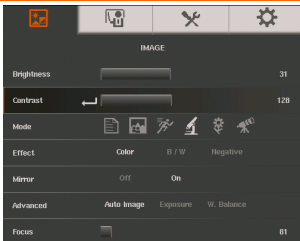

Contrast

Adjust the contrast level manually between 0 and 255 under bright and dark environments.

Menu Screen

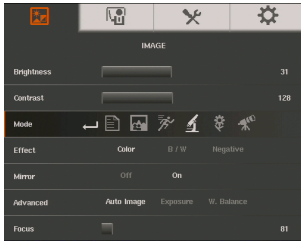



Function

Mode

Select from the various image display settings.

 **Sharp** - adjust the contrast along the edges making text appear more visible.

 **Graphics** - adjust the gradient of image.

 **Motion** - increase frame rate. Sufficient lighting is required when using this mode.

 **Microscope** - automatically adjust optical zoom for microscopic viewing.

 **Macro** - set to view when object is only 5 – 20 cm away from the camera.

 **Infinite** - set to view when subject is at least 55cm away from the camera.

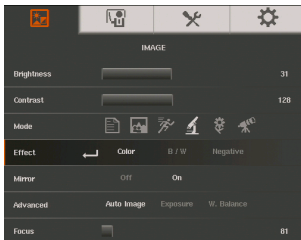
**Effect**

Convert the image into positive (true color), monochrome (black and white) or negative.

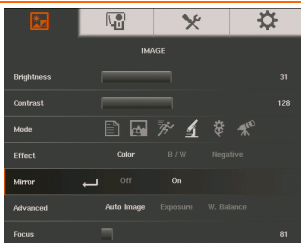
**Mirror**

Select to flip the image in Camera mode.

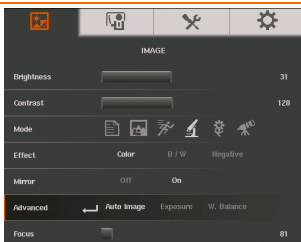
**Advanced**

Select to set the Auto Image, Exposure, and White Balance settings.

Menu Screen



Function

Auto Image

Select ON or OFF to automatically adjust the white balance and exposure setting, and correct the color and exposure compensation.

This will also set the lamp to automatically turn on when the light is not enough for the camera to adjust the focus.

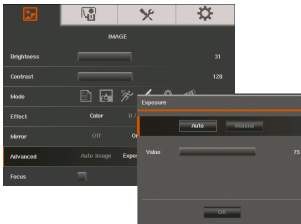
**Exposure**

Select the exposure setting.

AUTO - automatically adjust the camera exposure and the amount of light required.

MANUAL - manually adjust the exposure level. The exposure can be adjusted up to 100.

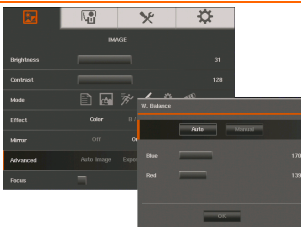
**White Balance**

Select the White Balance setting for various light conditions or color temperature.

AUTO - automatically adjust the white balance.

MANUAL - manually adjust the red and blue color level. The color level can be adjusted up to 255.

**Focus**

Manually adjust the focus.

Presentation

Menu Screen

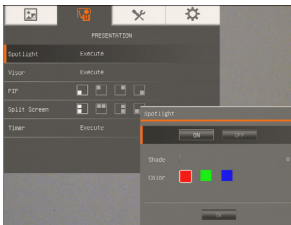

Function

Spotlight

Spotlight overlays a frame on the presentation screen. You can move the Spotlight around the presentation screen using the ▲, ▼, ◀, & ▶ buttons. Select Execute to call the Spotlight submenu.



In the Spotlight submenu, the following options are available.

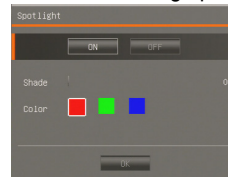

ON/OFF – select to run/cancel the Spotlight. Press ◀ to move to the next selection.

Shade – set the opacity level of the area outside the box. The shaded area will completely turn black when it is set to level 100. Press ◀ to move to the next selection.

Color – select the Spotlight frame color. Press ◀ to move to the next selection.

OK – press ◀ for the setting to take effect. If you select ON, the frame will appear and blink, use the ▲, ▼, ◀, & ▶ buttons to adjust the frame size and press ◀ to set the desired size; and OFF will close the submenu.

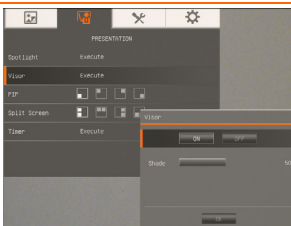

Visor

Visor covers the presentation screen. The upper part of the presentation screen is slightly exposed. Use the ▲, ▼, ◀, & ▶ buttons to reveal more of the covered area. Select Execute to call the Visor submenu.

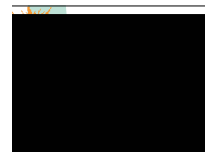

Menu Screen

Function

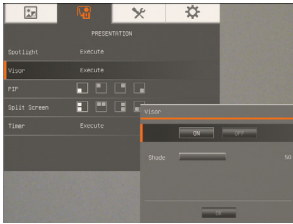

In the Visor submenu, the following options are available.

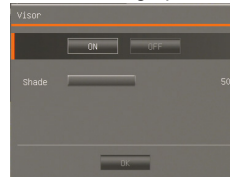

ON/OFF – select to run/cancel the Visor. Press to move to the next selection.

Shade – set the opacity level of the covered area. The shaded area will completely turns black when it is set to level 100. Press to move to the next selection.

OK – press for the setting to take effect. If you select ON, upper part of the presentation screen is slightly exposed. Use the , , , & buttons to reveal more of the covered area; and OFF will close the submenu.

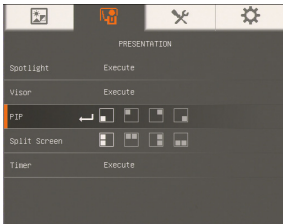

PIP

Select the thumbnail playback screen location and show the thumbnail playback screen at the corner of the screen to recall the captured image from the memory in Camera mode. Select OFF to cancel PIP.

- Lower Left
- Upper Left
- Upper Right
- Lower Right

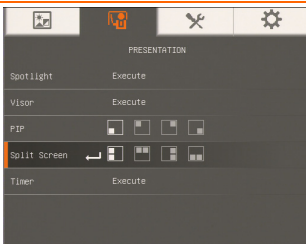

Split Screen

Divide the screen into two parts. Half of the screen displays the 8-thumbnail images and the other half display the image from the AVerVision F50 camera.

Select the display location of the 8- thumbnail playback images. Select OFF to cancel Split Screen.

- Left
- Right
- Top
- Below

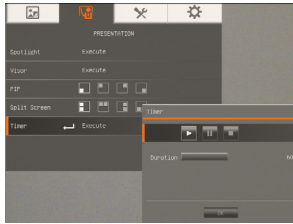

Menu Screen**Function****Timer**

Start/Pause/Stop the timer and set the timer duration. The timer automatically counts up after the count down reaches zero to show the elapsed time. Even when you switch between Playback, PC or Camera modes, the timer will continue.

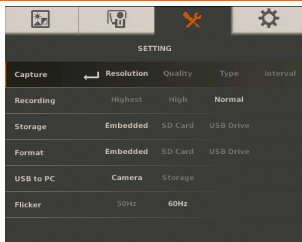
Setting**Menu Screen****Function****Capture**

Select to set the capture resolution, quality, type and interval settings.

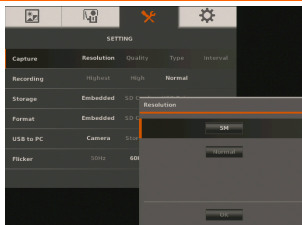
**Resolution**

Select the capture size. In 5M setting, the capture resolution size is 2560 X 1920.

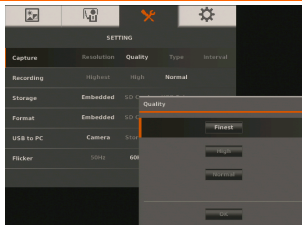
**Quality**

Select the capture compression setting.

Menu Screen

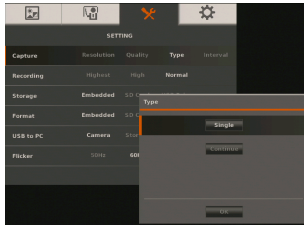

Function

Type

Select the capture type.

Single - capture one picture only.

Continuous - capture successive pictures.

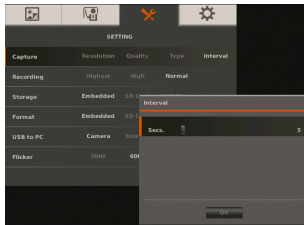
**Interval**

Set the time interval for continuous capture. The length can be set up to 600 sec (10 min).

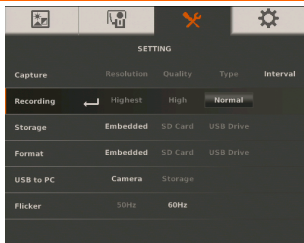
**Recording**

Select the video recording compression setting.

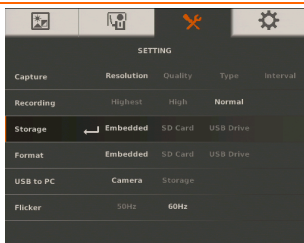
**Storage**

Change the storage location. Audio & video recording can only be saved in SD memory card or USB flash drive.

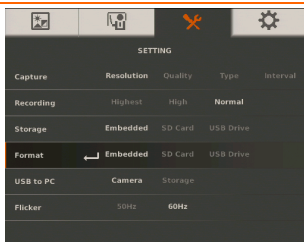
**Format**

Format to delete all the data in the selected memory.



Menu Screen

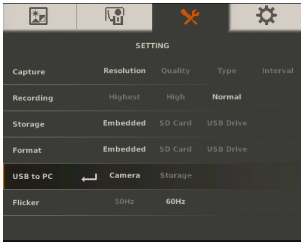

Function

USB to PC

Select the status of the AVerVision F50 when it is connected to the computer via USB. Make sure the USB switch on the left panel is set to .

Camera - can be used as a computer webcam or with our bundled software to record video and capture still image.

Storage - transfer the captured pictures/videos from the memory to computer hard disk.

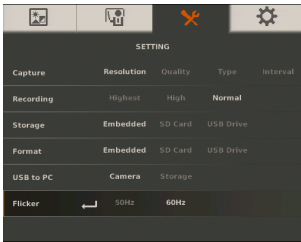
**Flicker**

Select between 50Hz or 60Hz. Some display devices cannot handle high refresh rates. The image will flicker a couple of times as the output is switched to another refresh rate.

System

Menu Screen

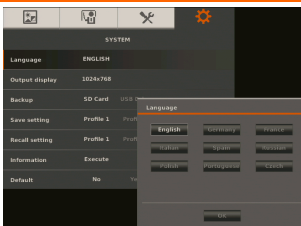

Function

Language

Change and select different language.

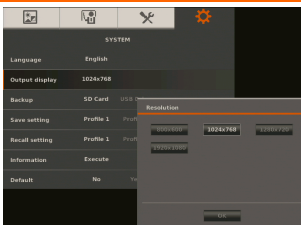
**Output Display**

Set the resolution to display the image on screen. This selection will be disabled in TV output mode.

Menu Screen

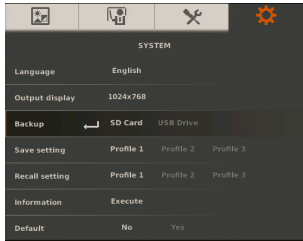

Function

Backup

Copy the image from the built-in memory to SD card or USB flash drive.

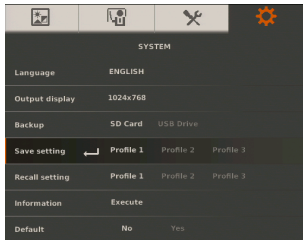
**Save Setting**

Save current setting in the selected profile number. Only effect, mode, brightness and contrast settings can be saved.

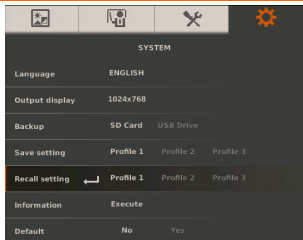
**Recall Setting**

Restore the setting back to the selected profile number.

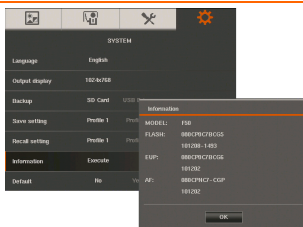
**Information**

Display the product information.

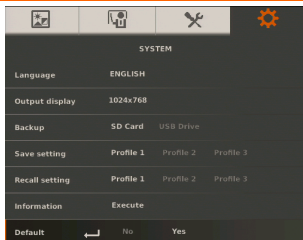
**Default**

Restore all the settings into original factory default setting.

Playback

Menu Screen

Function

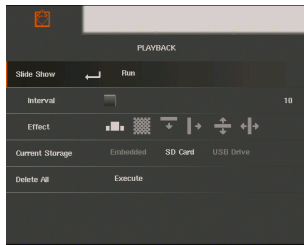

Slide Show

Display all captured still pictures in an automated slide show. The video file will be skipped.

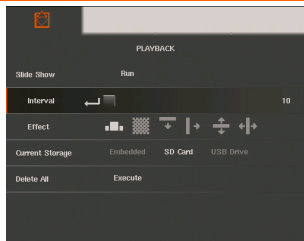

Interval

Set the interval before displaying the next picture. The length can be set up to 100 sec.

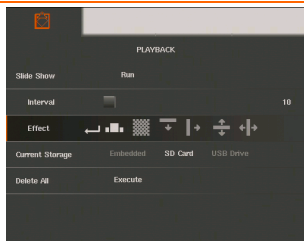

Slide Show Effect

Select the slide show transition effect.



Slide image



Checker down



Wipe down



Wipe right



Split Vertical Out



Split Horizontal In

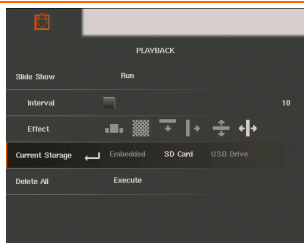

Current Storage

Select the source of the images.

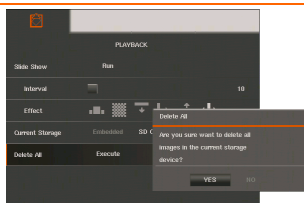

Delete All



Permanently delete all the data in selected memory source. A Warning Message will appear. Select YES to continue and NO to stop formatting the storage.

Annotation

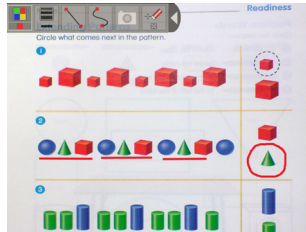
In single image playback mode, you can use the annotation feature to overlay straight line or freeform line on the captured image with the USB mouse connected to the USB port of AVerVision F50. It comes with the following selections: Color Palette, Line Thickness, Line, Freehand, Capture, Eraser, and Hide/Show icons.



Connecting a USB mouse



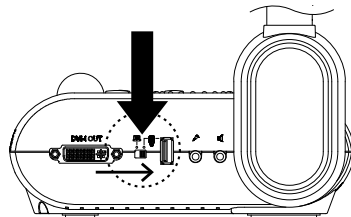

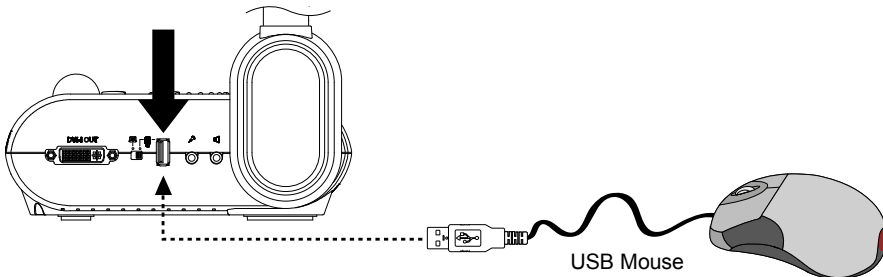

1. Set the USB switch on the left panel to . AVerVision F50 will then detect the USB mouse and the  LED on the control panel will light up.



2. Connect the USB cable to the USB slot of AVerVision F50.



Using the Annotation

1. Press  on the remote.
2. Use the , , , &  buttons and select the image you want to annotate in the 16-thumb nail preview.
3. Press  to make a selection and display the image in fullscreen.

- The annotation menu will appear on the upper left corner of the screen.

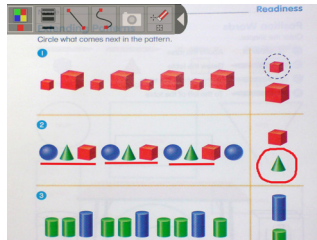

- Use the mouse and move the “+” cursor on the item in the annotation panel you want to use. Then left click the mouse button to make a selection.



Name	Function
Color Palette	Select the line color.
Line Thickness	Select the thickness of the line.
Line	Select to draw a straight line.
Freehand	Select to draw freeform line.
Capture	Capture the image with the annotation and save it as a new file.
Eraser	Select to erase any part of the annotation that it comes in contact with or delete all annotation.
Hide/Show	Shrink or expand the annotation menu.

Transfer Captured Images/Videos to a computer

This enables you to transfer the captured image from the built-in memory or SD to a computer.



The instruction below **MUST** be read and followed **BEFORE** connecting the USB cable.

- Make sure to set the USB switch to **PC** for the computer to detect AVerVision F50.
- MUST** set the USB to PC as STORAGE before connecting the USB cable.

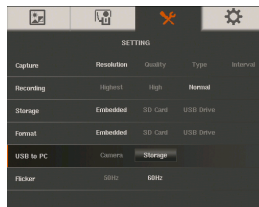

- When “**Mass Storage Start...**” appears at the lower right corner of the presentation screen, you may now connect the USB cable.
- Upon connecting the USB cable, the system automatically detects the new removable disk. You can now transfer the captured image(s) from the **F50 built-in memory** to the computer hard disk.

Technical Specifications

Image

Sensor	1/2.5" CMOS
Pixel Count	5 megapixels
Frame Rate	30 fps (max.)
White Balance	Auto / Manual
Exposure	Auto / Manual
Image mode	Sharp / Graphics / Motion / Microscope / Macro / Infinite
Effect	Color / B/W / Negative / Mirror / Rotate / Freeze
RGB output	1920x1080, 1280x720, 1024x768
DVI-I output	HD 1080p 50Hz/60Hz; HD 720p 50Hz/60Hz; XGA 60Hz;
Image Capture	240 Frames(XGA) ; 80 Frames(5M Pixel)

Optics

Focusing	Auto / Manual
Shooting Area	400mm x 300mm
Zooming	10X AVEROPTICAL™ (8X Optical+1.25X AVERZOOM™) 8X Digital Zoom

Power

Power Source	DC 12V, 100-240V, 50-60Hz
Consumption	16.8 Watts (lamp off); 18 Watts (lamp on)

Lighting

Lamp Type	LED light
-----------	-----------

Input/Output

RGB Input	15-Pins D-sub (VGA)
RGB Output	15-Pins D-sub (VGA)
DVI-I Output	DVI-I Type
CVBS/RS-232	Mini-DIN Jack (use CVBS/RS-232 Adapter cable)
Composite Video	RCA Jack
USB	USB2.0
DC 12V Input	Power Jack
MIC	Phone Jack
Speaker	Phone Jack

Dimension

Operating	380mm x 200mm x 540mm (+/-2mm include rubber foot)
Folded	305mm x 245mm x 77mm (+/-2mm include rubber foot)
Weight	2.6 kg (about 5.733lbs)

External Storage

Secure Digital (SDHC)	1GB ~ 32GB (FAT32)
USB Flash Drive	2GB ~ 64GB (FAT32)

Using the RS-232 Interface

AVerVision F50 can be controlled using a computer or any centralized control panel through RS-232 connection. The command code for RS-232 is provided for the system integrator to be able to incorporate it with the system program.

Connect to the Computer RS-232

Locate the RS-232 port of the computer and connect it to RS-232 jack of RS-232/CVBS cable.

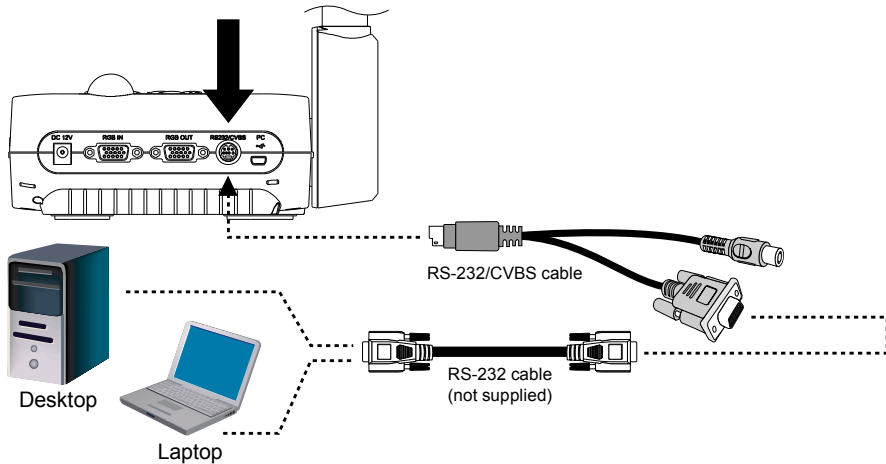

RS-232 Cable Specifications

Make sure the RS-232 cable matches the cable specification design.

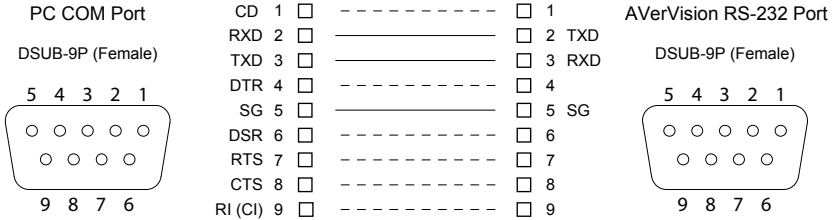

RS-232 Transmission Specifications

- Start bit : 1 bit
- Data bit : 8 bit
- Stop bit : 1 bit
- Parity bit : None
- X parameter : None
- Baud rate(Communication speed) : 9600bps

RS-232 Communication Format

- Send Device Code(1 Byte) : 0x52
- Type Code(1 Byte) : 0x0B
- DataLength Code(1 Byte) : 0x03
- Data Code(1 Byte) : See the Command Table for reference.
- Data Code(2 Byte) : See the Command Table for reference.
- Data Code(3 Byte) : See the Command Table for reference.
- Receive Device Code(1 Byte) : 0x53
- CheckSum Code(1 Byte) : See the Command Table for reference.
- Format : Start + Type + DataLength + Data + CheckSum
- Example : 0x52 + 0x0B + 0x03+ 0x3 + 0x01 + 0x00 + 0x00 + 0x53 + 0x5A (Command Power)

RS-232 Send Command Table

Send Format : 0x52 + 0x0B + 0x03 + Data[0] + Data[1] + Data[2] + 0x53 + CheckSum

Receive Format : 0x53 + 0x00 + 0x02+ *2 + *3 + 0x52 + CheckSum

*1 : CheckSum = 0x0B xor 0x03 xor Data[0] xor Data[1] xor Data[2] xor 0x53

*2 : Receive data ok : 0x0B, ID error: 0x01, CheckSum error: 0x02, Not Command : 0x03, Function fail = 0x04

*3 : Data[0], Return 0x00 if error



Function	Data[0]	Data[1]	Data[2]	Checksum
POWER OFF	0x01	0x00	0x00	0x5a
POWER ON	0x01	0x01	0x00	0x5b
CAMERA MODE	0x02	0x00	0x00	0x59
PLAYBACK MODE	0x03	0x00	0x00	0x58
PC-1 PASS THROUGH	0x04	0x00	0x00	0x5f
IMAGE CAPTURE TYPE: SINGLE	0x05	0x00	0x00	0x5e
IMAGE CAPTURE TYPE: CONTINUOUS	0x05	0x01	0x00	0x5f
IMAGE CAPTURE CONTINUOUS INTERVAL INCREASE	0x06	0x00	0x00	0x5d
IMAGE CAPTURE CONTINUOUS INTERVAL DECREASE	0x06	0x01	0x00	0x5c
NORMAL IMAGE CAPTURE	0x07	0x00	0x00	0x5c
3M/5M IMAGE CAPTURE	0x07	0x01	0x00	0x5d
TIMER START	0x08	0x00	0x00	0x53
TIMER PAUSE	0x08	0x01	0x00	0x52
TIMER STOP	0x08	0x02	0x00	0x51
TIMER SET TIME	0x08	0x03	Value [? ~ ?]	*1
PREVIEW MODE: SHARP	0x0A	0x00	0x00	0x51
PREVIEW MODE: GRAPHIC	0x0A	0x01	0x00	0x50
PREVIEW MODE: MOTION	0x0A	0x02	0x00	0x53
PREVIEW MODE: MICROSCOPE	0x0A	0x03	0x00	0x52
PREVIEW MODE: MACRO	0x0A	0x04	0x00	0x55
PREVIEW MODE: INFINITE	0x0A	0x05	0x00	0x54
PREVIEW MODE CAPTURE	0x0B	0x00	0x00	0x50
PLAYBACK DELETE	0x0C	0x00	0x00	0x57
PLAYBACK FULL SCREEN	0x0D	0x00	0x00	0x56
MIRROR OFF	0x0E	0x00	0x00	0x55
MIRROR ON	0x0E	0x01	0x00	0x54
ROTATE 0	0x0F	0x00	0x00	0x54
ROTATE 90	0x0F	0x01	0x00	0x55
ROTATE 180	0x0F	0x02	0x00	0x56

Function	Data[0]	Data[1]	Data[2]	Checksum
ROTATE 270	0x0F	0x03	0x00	0x57
EFFECT: COLOR	0x10	0x00	0x00	0x4b
EFFECT: B/W	0x10	0x01	0x00	0x4a
EFFECT: NEGATIVE	0x10	0x02	0x00	0x49
CONTRAST INCREASE	0x11	0x00	0x00	0x4a
CONTRAST DECREASE	0x11	0x01	0x00	0x4b
CONTRAST VALUE	0x11	0x02	Value [? ~ ?]	*1
BRIGHTNESS INCREASE	0x12	0x00	0x00	0x49
BRIGHTNESS DECREASE	0x12	0x01	0x00	0x48
BRIGHTNESS VALUE	0x12	0x02	Value [? ~ ?]	*1
EXPOSURE: AUTO	0x13	0x00	0x00	0x48
EXPOSURE: MANUAL	0x13	0x01	0x00	0x49
EXPOSURE MANUAL INCREASE	0x14	0x00	0x00	0x4f
EXPOSURE MANUAL DECREASE	0x14	0x01	0x00	0x4e
WHITE BALANCE: AUTO	0x15	0x00	0x00	0x4e
WHITE BALANCE: MANUAL	0x15	0x01	0x00	0x4f
WHITE BALANCE BLUE INCREASE	0x16	0x00	0x00	0x4d
WHITE BALANCE BLUE DECREASE	0x16	0x01	0x00	0x4c
WHITE BALANCE RED INCREASE	0x17	0x00	0x00	0x4c
WHITE BALANCE RED DECREASE	0x17	0x01	0x00	0x4d
FLICKER: 50Hz	0x18	0x00	0x00	0x43
FLICKER: 60Hz	0x18	0x01	0x00	0x42
SPOTLIGHT: OFF	0x19	0x00	0x00	0x42
SPOTLIGHT: ON	0x19	0x01	0x00	0x43
SPOTLIGHT SHADE: 0% dark	0x1A	0x00	0x00	0x41
SPOTLIGHT SHADE: 50% dark	0x1A	0x01	0x00	0x40
SPOTLIGHT SHADE: 100% dark	0x1A	0x02	0x00	0x43
SPOTLIGHT COLOR: RED	0x1B	0x00	0x00	0x40
SPOTLIGHT COLOR: GREEN	0x1B	0x01	0x00	0x41

Function	Data[0]	Data[1]	Data[2]	Checksum
SPOTLIGHT COLOR: BLUE	0x1B	0x02	0x00	0x42
SPOTLIGHT RESIZE	0x1C	0x00	0x00	0x47
VISOR: OFF	0x1D	0x00	0x00	0x46
VISOR: ON	0x1D	0x01	0x00	0x47
VISOR SHADE: 50% dark	0x1E	0x00	0x00	0x45
VISOR SHADE: 100% dark	0x1E	0x01	0x00	0x44
PIP: OFF	0x1F	0x00	0x00	0x44
PIP: ON	0x1F	0x01	0x00	0x45
PIP POSITION: BOTTOM LEFT	0x20	0x00	0x00	0x7b
PIP POSITION: TOP LEFT	0x20	0x01	0x00	0x7a
PIP POSITION: TOP RIGHT	0x20	0x02	0x00	0x79
PIP POSITION: BOTTOM RIGHT	0x20	0x03	0x00	0x78
SPLITSCREEN: OFF	0x21	0x00	0x00	0x7a
SPLITSCREEN: ON	0x21	0x01	0x00	0x7b
SPLITSCREEN DIR: UPPER SCREEN	0x22	0x00	0x00	0x79
SPLITSCREEN DIR: LOWER SCREEN	0x22	0x01	0x00	0x78
SPLITSCREEN DIR: LEFT SCREEN	0x22	0x02	0x00	0x7b
SPLITSCREEN DIR: RIGHT SCREEN	0x22	0x03	0x00	0x7a
RECORD: OFF	0x23	0x00	0x00	0x78
RECORD: ON	0x23	0x01	0x00	0x79
MOVIE FAST REWIND	0x25	0x00	0x00	0x7e
MOVIE FAST FORWARD	0x25	0x01	0x00	0x7f
MOVIE VOL INC	0x26	0x00	0x00	0x7d
MOVIE VOL DEC	0x26	0x01	0x00	0x7c
RECORD QUALITY: Normal	0x27	0x00	0x00	0x7c
RECORD QUALITY: High	0x27	0x01	0x00	0x7d
STORAGE: EMBEDDED	0x28	0x00	0x00	0x73
STORAGE: SD CARD	0x28	0x01	0x00	0x72
STORAGE: THUMB DRIVE	0x28	0x02	0x00	0x71

Function	Data[0]	Data[1]	Data[2]	Checksum
FORMAT: EMBEDDED	0x29	0x00	0x00	0x72
FORMAT: SD CARD	0x29	0x01	0x00	0x73
FORMAT: THUMB DRIVE	0x29	0x02	0x00	0x70
OUTPUT RESOLUTION: 1024x768	0x2F	0x01	0x00	0x75
OUTPUT RESOLUTION: 1280x720	0x2F	0x02	0x00	0x76
OUTPUT RESOLUTION: 1920x1080	0x2F	0x03	0x00	0x77
USB CONNECT: USB CAMERA	0x30	0x00	0x00	0x6b
USB CONNECT: MASS STORAGE	0x30	0x01	0x00	0x6a
BACKUP TO SD CARD	0x31	0x00	0x00	0x6a
BACKUP TO THUMBDRIVE	0x31	0x01	0x00	0x6b
PROFILE SAVE: PROFILE 1	0x32	0x00	0x00	0x69
PROFILE SAVE: PROFILE 2	0x32	0x01	0x00	0x68
PROFILE SAVE: PROFILE 3	0x32	0x02	0x00	0x6b
PROFILE RECALL: PROFILE 1	0x33	0x00	0x00	0x68
PROFILE RECALL: PROFILE 2	0x33	0x01	0x00	0x69
PROFILE RECALL: PROFILE 3	0x33	0x02	0x00	0x6a
SLIDESHOW: OFF	0x34	0x00	0x00	0x6f
SLIDESHOW: ON	0x34	0x01	0x00	0x6e
SLIDESHOW EFFECT: EFFECT 0	0x35	0x00	0x00	0x6e
SLIDESHOW EFFECT: EFFECT 1	0x35	0x01	0x00	0x6f
SLIDESHOW EFFECT: EFFECT 2	0x35	0x02	0x00	0x6c
SLIDESHOW EFFECT: EFFECT 3	0x35	0x03	0x00	0x6d
SLIDESHOW EFFECT: EFFECT 4	0x35	0x04	0x00	0x6a
SLIDESHOW EFFECT: EFFECT 5	0x35	0x05	0x00	0x6b
AUTO IMAGE:OFF	0x36	0x00	0x00	0x6d
AUTO IMAGE:ON	0x36	0x01	0x00	0x6c
CAPTURE QUALITY: STANDARD	0x37	0x00	0x00	0x6c
CAPTURE QUALITY: FINE	0x37	0x01	0x00	0x6d
CAPTURE QUALITY: FINEST	0x37	0x02	0x00	0x6e



Function	Data[0]	Data[1]	Data[2]	Checksum
AUTO FOCUS	0x40	0x00	0x00	0x1b
MENU	0x41	0x00	0x00	0x1a
ARROW - DOWN	0x42	0x00	0x00	0x19
ARROW - UP	0x42	0x01	0x00	0x18
ARROW - LEFT	0x42	0x02	0x00	0x1b
ARROW - RIGHT	0x42	0x03	0x00	0x1a
ENTER	0x43	0x00	0x00	0x18
FREEZE	0x44	0x00	0x00	0x1f
DEFAULT	0x45	0x00	0x00	0x1e
ZOOM -	0x46	0x00	0x00	0x1d
ZOOM +	0x46	0x01	0x00	0x1c
ZOOM RESET	0x47	0x00	0x00	0x1c
NEAR	0x48	0x00	0x00	0x13
FAR	0x48	0x01	0x00	0x12
LAMP OFF	0x49	0x00	0x00	0x12
LAMP ON	0x49	0x01	0x00	0x13

RS-232 Get Command Table

Send Format : 0x52 + 0x0A + 0x01 + Data[0] + 0x53 + CheckSum

Receive Format : 0x53 + 0x0C + 0x01 + ReData[0] + 0x53 + ReCheckSum

*1 : ReCheckSum = 0x0C xor 0x01 xor ReData[0] xor 0x52

Function	Data[0]	Checksum Code	ReData[0]
Red Value	0x02	0x5A	Value[? ~ ?]
Blue Value	0x03	0x5B	Value[? ~ ?]
Power Status	0x04	0x5C	0 : OFF 1: ON
Lamp Status	0x05	0x5D	0 : OFF 1: ON
Display Status	0x06	0x5E	0: Camera Mode 1: Playback Mode 2: PC-1 Pass Through
Video Output Status	0x07	0x5F	0: VGA 1: TV
Freeze Status	0x08	0x50	0 : OFF 1: ON

Function	Data[0]	CheckSum Code	ReData[0]
Brightness Value	0x0A	0x52	Value[? ~ ?]
Contrast Value	0x0B	0x53	Value[? ~ ?]
LIGHT BOX Status	0x0C	0x54	0 : OFF 1 : ON

Troubleshooting

This section provides many useful tips on how to solve common problems while using the AVerVision F50.

There is no picture on the presentation screen.

1. Check all the connectors again as shown in this manual.
2. Check the on/off switch of the display output device.
3. Verify the setting of the display output device.
4. If you are presenting from a notebook or computer through the display output device, check the cable connection from computer RGB (VGA) output to RGB input of AVerVision F50 and make sure AVerVision F50 is in PC Mode.

I have set up the AVerVision F50 and checked all the connections as specified in the manual but I cannot get a picture on the preferred presentation screen.

1. Once the power is connected the unit is set to standby mode. Press the POWER button to turn on.
2. If your display output device is on TV or any analog device, please switch the TV-RGB dip switch to TV.

The picture on the presentation screen is distorted or the image is blurry.

1. Reset all changed settings, if any, to the original manufacturer default setting. Press MENU then go to SYSTEM > Default and select YES in the OSD menu.
2. Use the Brightness and Contrast menu functions to reduce the distortion if applicable.
3. If you discover that the image is blurry or out of focus, press the Auto Focus button on the control panel or remote control.

There is no computer signal on presentation screen.

1. Check all the cable connections among the display device, AVerVision F50 and your PC.
2. Connect your PC to the AVerVision F50 first before you power on your computer.
3. For notebook, repeatedly press FN+F5 to toggles between display modes and display the computer image on the presentation screen. For different command, please refer to your laptop manual.

The presentation screen does not show the exact desktop image on my PC or Notebook after I toggle from Camera to PC mode.

1. Return to your PC or Notebook, place the mouse on the desktop and right click, choose "Properties", choose "Setting" tab, click on "2" monitor and check the box "Extend my Windows desktop onto this monitor".
2. Then go back one more time to your PC or Notebook and place the mouse on the desktop and right click again.
3. This time choose "Graphics Options", then "Output To", then "Intel® Dual Display Clone", and then choose "Monitor + Notebook".
4. After you follow these steps, you should be able to see the same desktop image on your PC or Notebook as well as on the presentation screen.

AVerVision F50 can't detect the inserted USB flash drive.

Make sure the USB flash drive switch is set to  and check if the USB flash drive is properly inserted.

Limited Warranty

For a period of time beginning on the date of purchase of the applicable product and extending as set forth in the **“Warranty Period of AVer Product Purchased”** section of the warranty card, AVer Information, Inc. (“AVer”) warrants that the applicable product (“Product”) substantially conforms to AVer’s documentation for the product and that its manufacture and components are free of defects in material and workmanship under normal use. “You” as used in this agreement means you individually or the business entity on whose behalf you use or install the product, as applicable. This limited warranty extends only to You as the original purchaser. Except for the foregoing, the Product is provided “AS IS.” In no event does AVer warrant that You will be able to operate the Product without problems or interruptions, or that the Product is suitable for your purposes. Your exclusive remedy and the entire liability of AVer under this paragraph shall be, at AVer’s option, the repair or replacement of the Product with the same or a comparable product. This warranty does not apply to (a) any Product on which the serial number has been defaced, modified, or removed, or (b) cartons, cases, batteries, cabinets, tapes, or accessories used with this product. This warranty does not apply to any Product that has suffered damage, deterioration or malfunction due to (a) accident, abuse, misuse, neglect, fire, water, lightning, or other acts of nature, commercial or industrial use, unauthorized product modification or failure to follow instructions included with the Product, (b) misapplication of service by someone other than the manufacturer’s representative, (c) any shipment damages (such claims must be made with the carrier), or (d) any other causes that do not relate to a Product defect. The Warranty Period of any repaired or replaced Product shall be the longer of (a) the original Warranty Period or (b) thirty (30) days from the date of delivery of the repaired or replaced product.

Limitations of Warranty

AVer makes no warranties to any third party. You are responsible for all claims, damages, settlements, expenses, and attorneys’ fees with respect to claims made against You as a result of Your use or misuse of the Product. This warranty applies only if the Product is installed, operated, maintained, and used in accordance with AVer specifications. Specifically, the warranties do not extend to any failure caused by (i) accident, unusual physical, electrical, or electromagnetic stress, neglect or misuse, (ii) fluctuations in electrical power beyond AVer specifications, (iii) use of the Product with any accessories or options not furnished by AVer or its authorized agents, or (iv) installation, alteration, or repair of the Product by anyone other than AVer or its authorized agents.

Disclaimer of Warranty

EXCEPT AS EXPRESSLY PROVIDED OTHERWISE HEREIN AND TO THE MAXIMUM EXTENT PERMITTED BY APPLICABLE LAW, AVER DISCLAIMS ALL OTHER WARRANTIES WITH RESPECT TO THE PRODUCT, WHETHER EXPRESS, IMPLIED, STATUTORY OR OTHERWISE, INCLUDING WITHOUT LIMITATION, SATISFACTORY QUALITY, COURSE OF DEALING, TRADE USAGE OR PRACTICE OR THE IMPLIED WARRANTIES OF MERCHANTABILITY, FITNESS FOR A PARTICULAR PURPOSE OR NONINFRINGEMENT OF THIRD PARTY RIGHTS.

Limitation of Liability

IN NO EVENT SHALL AVER BE LIABLE FOR INDIRECT, INCIDENTAL, SPECIAL, EXEMPLARY, PUNITIVE, OR CONSEQUENTIAL DAMAGES OF ANY NATURE INCLUDING, BUT NOT LIMITED TO, LOSS OF PROFITS, DATA, REVENUE, PRODUCTION, OR USE, BUSINESS INTERRUPTION, OR PROCUREMENT OF SUBSTITUTE GOODS OR SERVICES ARISING OUT OF OR IN CONNECTION WITH THIS LIMITED WARRANTY, OR THE USE OR PERFORMANCE OF ANY PRODUCT, WHETHER BASED ON CONTRACT OR TORT, INCLUDING NEGLIGENCE, OR ANY OTHER LEGAL THEORY, EVEN IF AVER HAS ADVISED OF THE POSSIBILITY OF SUCH DAMAGES. AVER’S TOTAL, AGGREGATE LIABILITY FOR DAMAGES OF ANY NATURE,

REGARDLESS OF FORM OF ACTION, SHALL IN NO EVENT EXCEED THE AMOUNT PAID BY YOU TO AVER FOR THE SPECIFIC PRODUCT UPON WHICH LIABILITY IS BASED.

Governing Law and Your Rights

This warranty gives you specific legal rights; You may also have other rights granted under state law. These rights vary from state to state.



For warranty period, please refer to the warranty card.

