



# **AVer Vandal Dome type Camera**

## **Installation Guide**



# Table of Contents

<b>Important Safeguard .....</b>	<b>1</b>
<b>Package Contents.....</b>	<b>2</b>
Optional Accessories .....	2
<b>IP Camera Parts .....</b>	<b>3</b>
<b>IP Camera Installation .....</b>	<b>4</b>
Deploying Network.....	4
Network Connection via Ethernet Switch .....	4
Power over Ethernet Connection.....	5
Connecting External Devices to I/O Terminal Block .....	6
Internal Connection Diagram of DI/DO .....	6
Mounting the IP Camera .....	7
Focusing the IP Camera with BNC Monitor.....	8
Inserting microSD Card to System.....	9
Resetting Hardware .....	10
<b>Technical Specifications .....</b>	<b>11</b>
SF2121H-DVR.....	11
<b>Federal Communications Commission Statement (Class B)....</b>	<b>12</b>
<b>Class B (EMC) .....</b>	<b>13</b>
<b>COPYRIGHT .....</b>	<b>13</b>
<b>NOTICE .....</b>	<b>13</b>
<b>WARNING .....</b>	<b>13</b>
<b>Limited Warranty .....</b>	<b>14</b>
<b>Limitations of Warranty.....</b>	<b>14</b>
<b>Disclaimer of Warranty .....</b>	<b>14</b>
<b>Limitation of Liability .....</b>	<b>14</b>
<b>Governing Law and Your Rights .....</b>	<b>15</b>

## Important Safeguard

Do not use power supply with different voltage other than DC 12V / PoE.

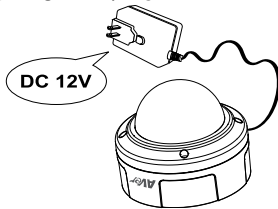

Unplug the power of this unit as soon as smoke or unusual odor is detected.

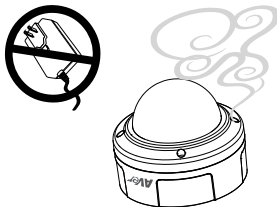

Do not attempt to service this unit by yourself. Always refer all servicing to qualified service personnel.

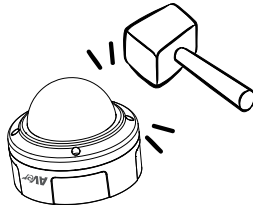

Keep the IP camera housing close and prevent the dust from getting in the housing.



Do not submerge the unit in the water.

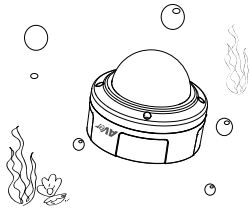

Unplug the power supply before cleaning. Use only a lens cleaning cloth and never use benzene, thinner, or other solvent for cleaning.

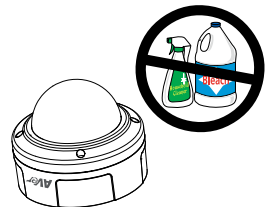

Do not place the unit in unsteady surface and also do not drop the unit.

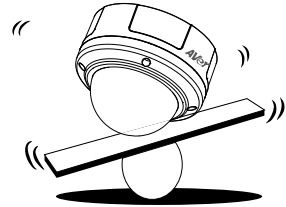

## Package Contents

The following items are included in the package.

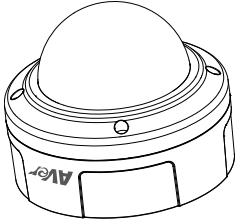

AVer Vandal Dome type  
Camera



Software & Manual CD

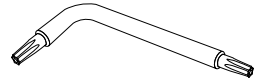

L-type Wrench

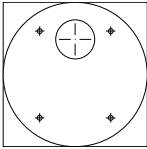

Alignment Sticker



4 Screws

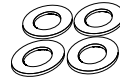

4 Washers

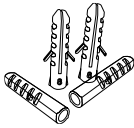

4 Plastic Anchors

## Optional Accessories

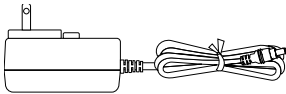

Power Adapter (12V, 2A)

\* The power adapter will vary depending on the standard power outlet of the country where it is sold. Depending on your package the power adapter maybe included.

## IP Camera Parts

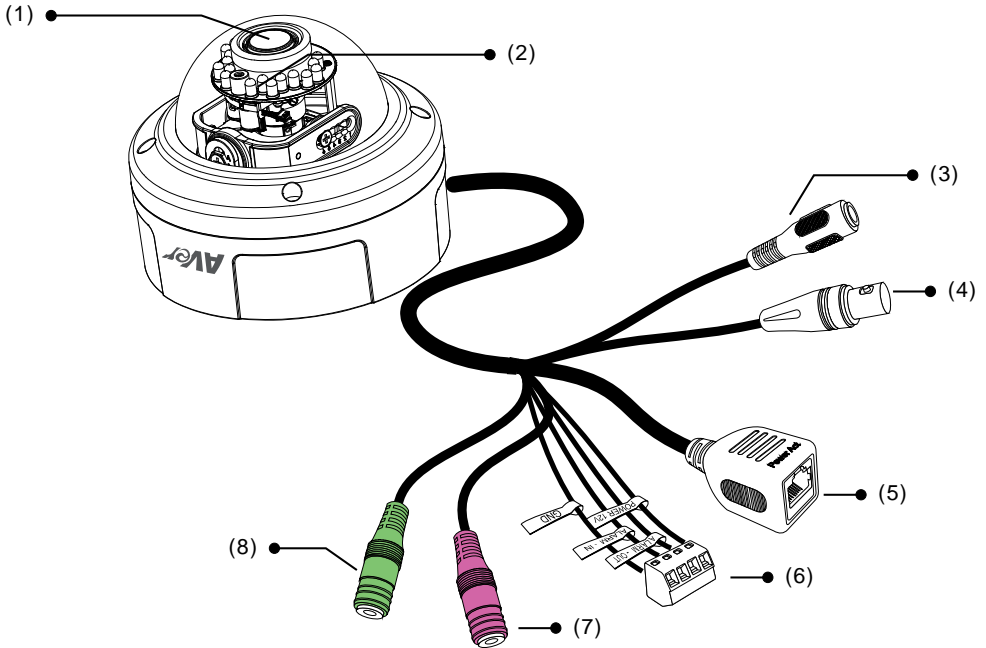

No.	Function
(1)	Camera Lens
(2)	Light Sensor
(3)	Power Jack
(4)	BNC Jack (Video Out)
(5)	RJ45 Ethernet Jack
(6)	I/O Terminal Block
(7)	Phone Jack (Audio In)
(8)	Phone Jack (Audio Out)

# IP Camera Installation

This section provides useful tips on how to adjust the IP camera to meet your needs.

## Deploying Network

### Network Connection via Ethernet Switch

- Connect the RJ45 cable from the Ethernet switch to RJ45 Ethernet jack of camera

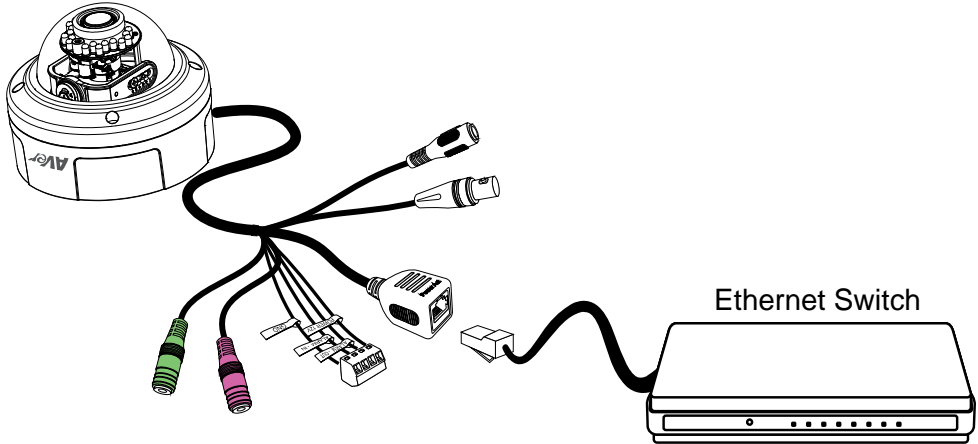

- Connect the power adapter to power jack of camera.

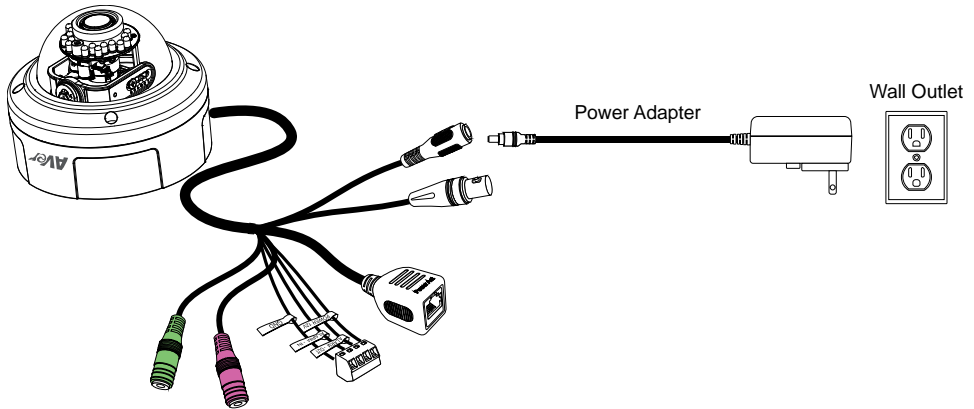

## Power over Ethernet Connection

AVer vandal dome type camera fully complies with PoE standard. It allows you to use PoE enabled switch or PoE injector to transmit data and power thru single Ethernet cable.

- PoE Enabled Switch Connection Diagram

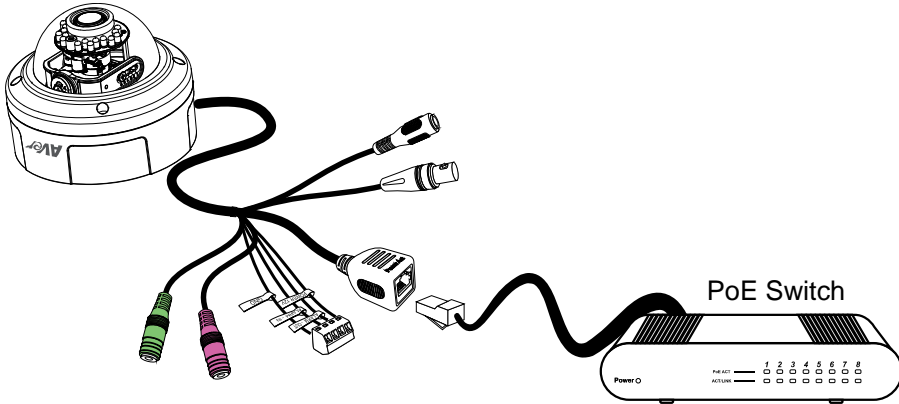

- PoE Injector Connection Diagram

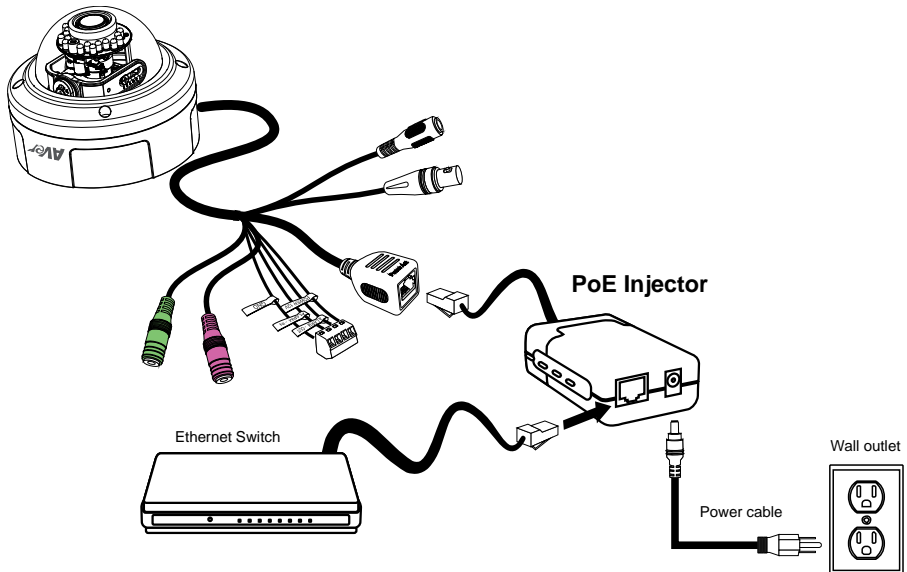

## Connecting External Devices to I/O Terminal Block



- 1 Power 12V
- 2 Digital output
- 3 Digital input
- 4 Ground

No.	Function
(1)	Power 12V
(2)	Digital Output
(3)	Digital Input
(4)	Ground

**Note:** Maximum power output is 12V/100mA

## Internal Connection Diagram of DI/DO

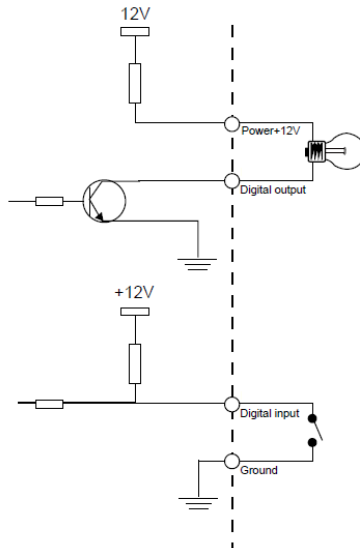

## Mounting the IP Camera

1. Place the sticker on the wall surface.  
Then spot the mark and drill the 5 holes indicated on the sticker.  
If you are going to run the wire through the lateral side, it's not necessary to drill through the big hole.

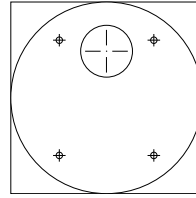

2. Insert the 4 plastic anchors in the wall.

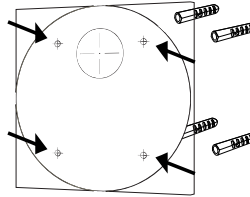

3. Hook the IP Camera and place the washer on the 4 screws. Use the hex socket cap bolt to secure the IP camera.

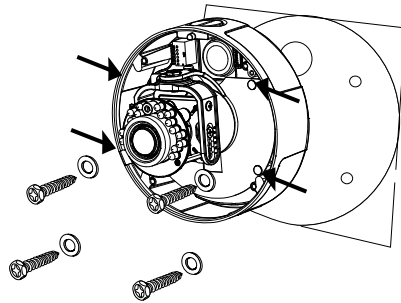

4. After adjusting the focus and zoom control, use the L-type wrench to secure the case of IP camera from being tampered.

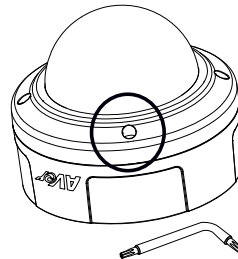

## Focusing the IP Camera with BNC Monitor

The IP camera is supported with BNC analog video out jack which allows you to connect an analog display devices such as an LCD BNC monitor for you to adjust the camera focus and zoom.

1. Connect the LCD BNC monitor to the BNC jack.

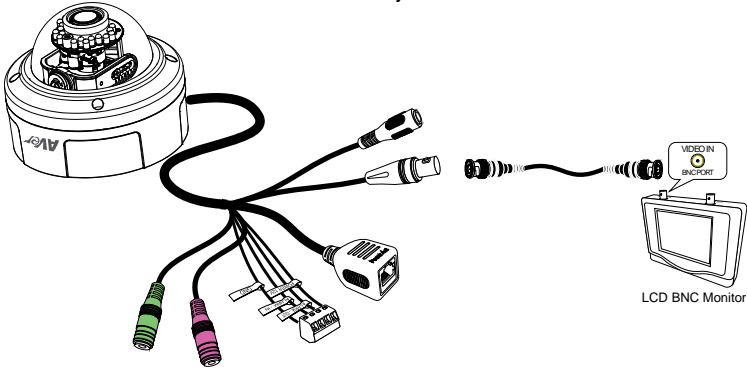

2. Open up the IP camera case.

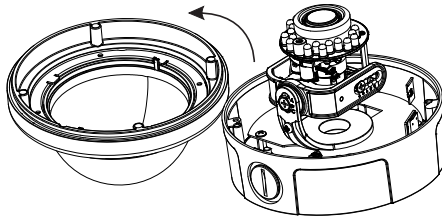

3. Slightly loosen the focus and zoom control knobs and adjust the focus and zoom range. Slightly tighten the focus and zoom knobs once you are done adjusting.

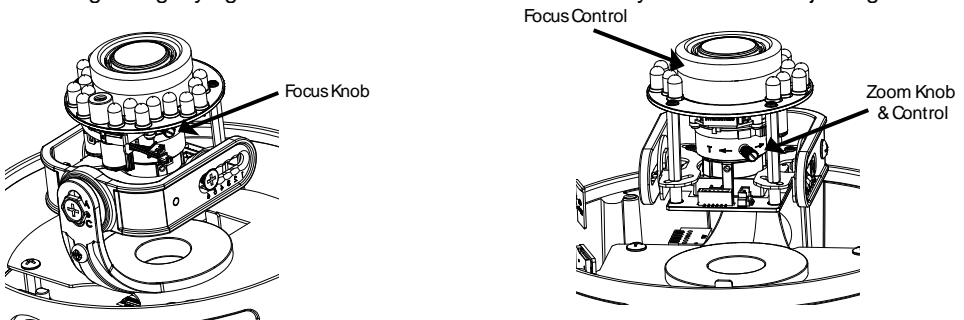

## Inserting microSD Card to System

1. Open up the IP camera case.

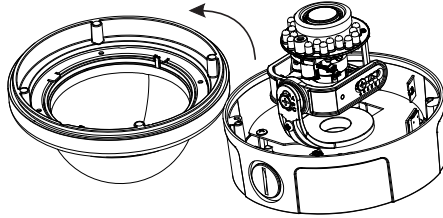

2. Insert microSD card

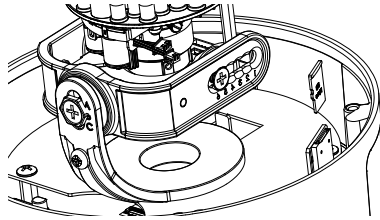

We recommend to use industrial grade microSD card (support operating temp from -40°C to 85°C) for extreme temperature condition.

## Resetting Hardware

1. Open the IP camera case.

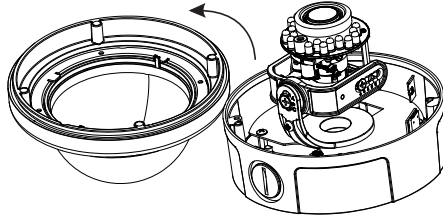

2. Short PJ1 pins around 10 seconds.



**Warning!! This will cause all the configuration settings back to factory default.**

## Technical Specifications

### SF2121H-DVR

Lens spec.		CBC AG3Z0312LMRP-N
Lens type	Vari-focal Lens (Board mount, M19)	
F/no	F/1.2	
Iris type	DC-Iris	
Focal length	f3~9mm	
View Angle	H 121.2°(W)~38.1°(T) V 62.1°(W)~21.3°(T)	
Camera image		
Min. illumination	0.4 Lux in day mode (IR off) 0 Lux in night mode (IR on)	
Built-in LED	yes	
IR distance	30M	
Built-in mechanical ICR	yes	
Auto IRIS	yes	
Video		
Compression	H.264/MPEG-4/MJPEG	
Max. resolution	1920 x 1080	
Frame rate	1920 x 1080 @ 30fps	
H.264/MPEG-4 bit rate mode	VBR, 5 levels CBR, 64/128/512/768Kbps & 1/2/3/4/6/8/10/12Mbps	
MJPEG quality	5 levels	
Regional of Interest	yes	
Smart Stream	yes, 5 windows	
Image orientation	mirror, flip	
Motion Detection zones	3	
Privacy mask areas	3	
BLC	yes	
D-WDR	yes	
De-noise	2D/3D	
Day & night function	Auto/Manual/Schedule	
ePTZ	yes	
Audio		
Encoder	G.711 (μ-law)/G.726 (bit rate 16K~64bps) /AAC audio compression	
Streaming	2-ways audio	
Network		
protocols	TCP/IP (IPv4/IPv6), HTTP, HTTPS, UPnP, SMTP, FTP, DHCP, NTP, DDNS, PPPoE, Samba, QoS	
Ethernet	10/100 Base-T, RJ45 connector	
ONVIF	V2.X (Profile S), conformance test V12.06	
Security	Password protection/IP Filter	

	Users	up to 10 users simultaneously
<b>Event</b>	Profiles	32 sets
	Triggers	Alarm Interval, Motion Detection Region, Digital Input, SD Card, Network
	Actions	Trigger: Digital Output, Alarm Audio Send out video clip: FTP, NAS, SD card Send out snapshot / log: FTP, NAS, SD card, mail
<b>Interface</b>	Digital input/output	1/1
	BNC Video output	yes
	Built-in storage option	Micro SDHC card (32GB max.)
	External microphone input	yes
	External Audio output	yes
<b>General</b>	Power supply	DC 12V/PoE
	Power consumption	PoE (TYP.): 7W (LED/Heater off) 8.3W (LED on, Heater off) 14.5W (LED off, Heater on) 15.5W (LED/Heater on) DC-IN (TYP.) 5W (LED/Heater off) 6W (LED on, Heater off) 11.3W (LED off, Heter on) 12.4W (LED/Hearer on)
	PoE	PoE Class 3 (IEEE802.3af)
	Dimensions	φ144.3 x H114.4 (mm)
	3-axis bracket adjustment angle	pan: 280°, tilt: 30°~90°, rotation: 100°
	Net weight	1200g
	Temperature and humidity	-15°C~50°C, 20%~90% Cold Start -25°C~50°C, 20%~90% Operating
	IP Rating	IP68
	IK Rating	IK10
<b>Software Requirements</b>	OS	Windows® XP/7/8
	Browser	IE 8/9/10
	Firmware remote upgrade	yes (via HTTP)
<b>Warranty</b>	Main body	2 years
	Accessories	1 year

## Federal Communications Commission Statement

## (Class B)

**FC** This device complies with Part 15 of the FCC Rules. Operation is subject to the following two conditions: (1) this device may not cause harmful interference, and (2) this device must accept any interference received, including interference that may cause undesired operation.

NOTE- This equipment has been tested and found to comply with the limits for a Class B digital device, pursuant to Part 15 of the FCC Rules. These limits are designed to provide reasonable protection against harmful interference in a residential installation. This equipment generates uses and can radiate radio frequency energy and, if not installed and used in accordance with the instructions, may cause harmful interference to radio communications. However, there is no guarantee that interference will not occur in a particular installation. If this equipment does cause harmful interference to radio or television reception, which can be determined by tuning the equipment off and on, the user is encouraged to try to correct the interference by one or more of the following measures:

- Reorient or relocate the receiving antenna.
- Increase the separation between the equipment and receiver.
- Connect the equipment into an outlet on a circuit different from that to which the receiver is connected.
- Consult the dealer or an experienced radio/television technician for help.

## Class B (EMC)

**CE** This product is herewith confirmed to comply with the requirements set out in the Council Directives on the Approximation of the laws of the Member States relating to Electromagnetic Compatibility Directive 2004/108/EC.

## COPYRIGHT

© 2013 AVer Information Inc. All rights reserved.

All rights of this object belong to AVer Information Inc. Reproduced or transmitted in any form or by any means without the prior written permission of AVer Information Inc. is prohibited. All information or specifications are subject to change without prior notice. "AVer" is a trademark owned by AVer Information Inc. Other trademarks used herein for description purpose only belong to each of their companies.

## NOTICE

SPECIFICATIONS ARE SUBJECT TO CHANGE WITHOUT PRIOR NOTICE. THE INFORMATION CONTAINED HEREIN IS TO BE CONSIDERED FOR REFERENCE ONLY.

## WARNING

TO REDUCE RISK OF FIRE OR ELECTRIC SHOCK, DO NOT EXPOSE THIS APPLIANCE TO RAIN OR MOISTURE. WARRANTY VOID FOR ANY UNAUTHORIZED PRODUCT MODIFICATION.



THE MARK OF CROSSED-OUT WHEELED BIN INDICATES THAT THIS PRODUCT MUST NOT BE DISPOSED OF WITH YOUR OTHER HOUSEHOLD WASTE. INSTEAD, YOU NEED TO DISPOSE OF THE WASTE EQUIPMENT BY HANDING IT OVER TO A DESIGNATED COLLECTION POINT FOR THE RECYCLING OF WASTE ELECTRICAL AND ELECTRONIC EQUIPMENT. FOR MORE INFORMATION ABOUT WHERE TO DROP OFF YOUR WASTE EQUIPMENT FOR RECYCLING, PLEASE CONTACT YOUR HOUSEHOLD WASTE DISPOSAL SERVICE OR THE SHOP WHERE YOU PURCHASED THE PRODUCT.

## Limited Warranty

For a period of time beginning on the date of purchase of the applicable product and extending as set forth in the **“Warranty Period of AVer Product Purchased”** section of the warranty card, AVer Information, Inc. (“AVer”) warrants that the applicable product (“Product”) substantially conforms to AVer’s documentation for the product and that its manufacture and components are free of defects in material and workmanship under normal use. “You” as used in this agreement means you individually or the business entity on whose behalf you use or install the product, as applicable. This limited warranty extends only to You as the original purchaser. Except for the foregoing, the Product is provided “AS IS.” In no event does AVer warrant that You will be able to operate the Product without problems or interruptions, or that the Product is suitable for your purposes. Your exclusive remedy and the entire liability of AVer under this paragraph shall be, at AVer’s option, the repair or replacement of the Product with the same or a comparable product. This warranty does not apply to (a) any Product on which the serial number has been defaced, modified, or removed, or (b) cartons, cases, batteries, cabinets, tapes, or accessories used with this product. This warranty does not apply to any Product that has suffered damage, deterioration or malfunction due to (a) accident, abuse, misuse, neglect, fire, water, lightning, or other acts of nature, commercial or industrial use, unauthorized product modification or failure to follow instructions included with the Product, (b) misapplication of service by someone other than the manufacturer’s representative, (c) any shipment damages (such claims must be made with the carrier), or (d) any other causes that do not relate to a Product defect. The Warranty Period of any repaired or replaced Product shall be the longer of (a) the original Warranty Period or (b) thirty (30) days from the date of delivery of the repaired or replaced product.

### Limitations of Warranty

AVer makes no warranties to any third party. You are responsible for all claims, damages, settlements, expenses, and attorneys’ fees with respect to claims made against You as a result of Your use or misuse of the Product. This warranty applies only if the Product is installed, operated, maintained, and used in accordance with AVer specifications. Specifically, the warranties do not extend to any failure caused by (i) accident, unusual physical, electrical, or electromagnetic stress, neglect or misuse, (ii) fluctuations in electrical power beyond AVer specifications, (iii) use of the Product with any accessories or options not furnished by AVer or its authorized agents, or (iv) installation, alteration, or repair of the Product by anyone other than AVer or its authorized agents.

### Disclaimer of Warranty

EXCEPT AS EXPRESSLY PROVIDED OTHERWISE HEREIN AND TO THE MAXIMUM EXTENT PERMITTED BY APPLICABLE LAW, AVER DISCLAIMS ALL OTHER WARRANTIES WITH RESPECT TO THE PRODUCT, WHETHER EXPRESS, IMPLIED, STATUTORY OR OTHERWISE, INCLUDING WITHOUT LIMITATION, SATISFACTORY QUALITY, COURSE OF DEALING, TRADE USAGE OR PRACTICE OR THE IMPLIED WARRANTIES OF MERCHANTABILITY, FITNESS FOR A PARTICULAR PURPOSE OR NONINFRINGEMENT OF THIRD PARTY RIGHTS.

### Limitation of Liability

IN NO EVENT SHALL AVER BE LIABLE FOR INDIRECT, INCIDENTAL, SPECIAL, EXEMPLARY, PUNITIVE, OR CONSEQUENTIAL DAMAGES OF ANY NATURE INCLUDING, BUT NOT LIMITED TO,

LOSS OF PROFITS, DATA, REVENUE, PRODUCTION, OR USE, BUSINESS INTERRUPTION, OR PROCUREMENT OF SUBSTITUTE GOODS OR SERVICES ARISING OUT OF OR IN CONNECTION WITH THIS LIMITED WARRANTY, OR THE USE OR PERFORMANCE OF ANY PRODUCT, WHETHER BASED ON CONTRACT OR TORT, INCLUDING NEGLIGENCE, OR ANY OTHER LEGAL THEORY, EVEN IF AVER HAS ADVISED OF THE POSSIBILITY OF SUCH DAMAGES. AVER'S TOTAL, AGGREGATE LIABILITY FOR DAMAGES OF ANY NATURE, REGARDLESS OF FORM OF ACTION, SHALL IN NO EVENT EXCEED THE AMOUNT PAID BY YOU TO AVER FOR THE SPECIFIC PRODUCT UPON WHICH LIABILITY IS BASED.

**Governing Law and Your Rights**

This warranty gives you specific legal rights; you may also have other rights granted under state law. These rights vary from state to state.